

**UNITED STATES
SECURITIES AND EXCHANGE COMMISSION**
Washington, D.C. 20549

Form 8-K

**CURRENT REPORT
Pursuant to Section 13 or 15(d)
of the Securities Exchange Act of 1934**

Date of Report (Date of earliest event reported): January 11, 2021

WAVE LIFE SCIENCES LTD.

(Exact name of registrant as specified in its charter)

Singapore
(State or other jurisdiction
of incorporation)

001-37627
(Commission
File Number)

00-0000000
(IRS Employer
Identification No.)

**7 Straits View #12-00, Marina One
East Tower
Singapore**
(Address of principal executive offices)

018936
(Zip Code)

Registrant's telephone number, including area code: +65 6236 3388

Check the appropriate box below if the Form 8-K filing is intended to simultaneously satisfy the filing obligation of the registrant under any of the following provisions (see General Instruction A.2. below):

- Written communications pursuant to Rule 425 under the Securities Act (17 CFR 230.425)
- Soliciting material pursuant to Rule 14a-12 under the Exchange Act (17 CFR 240.14a-12)
- Pre-commencement communications pursuant to Rule 14d-2(b) under the Exchange Act (17 CFR 240.14d-2(b))
- Pre-commencement communications pursuant to Rule 13e-4(c) under the Exchange Act (17 CFR 240.13e-4(c))

Securities registered pursuant to Section 12(b) of the Act:

Title of each class	Trading symbol	Name of each exchange on which registered
\$0 Par Value Ordinary Shares	WVE	The Nasdaq Global Market

Indicate by check mark whether the registrant is an emerging growth company as defined in Rule 405 of the Securities Act of 1933 (§230.405 of this chapter) or Rule 12b-2 of the Securities Exchange Act of 1934 (§240.12b-2 of this chapter).

Emerging growth company

If an emerging growth company, indicate by check mark if the registrant has elected not to use the extended transition period for complying with any new or revised financial accounting standards provided pursuant to Section 13(a) of the Exchange Act.

Item 7.01 Regulation FD Disclosure.

From time to time, Wave Life Sciences Ltd. (the “Company”) presents and/or distributes slides and presentations to the investment community to provide updates and summaries of its business. On January 11, 2021, the Company updated its corporate presentation, which is available on the “For Investors & Media” section of the Company’s website at <http://ir.wavelifesciences.com/>. This presentation is also furnished as Exhibit 99.1 to this Current Report on Form 8-K.

The information set forth in Exhibit 99.1 is being furnished and shall not be deemed “filed” for purposes of Section 18 of the Securities Exchange Act of 1934, as amended (the “Exchange Act”), or otherwise subject to the liabilities of that Section, nor shall it be deemed incorporated by reference into any registration statement or other filing under the Securities Act of 1933, as amended, or the Exchange Act, except as shall be expressly set forth by specific reference in such filing.

Item 8.01 Other Events.

On January 11, 2021, the Company issued a press release providing key upcoming milestones for 2021, including the initiation of new clinical trials, expected data read-outs, and continued advancement of the Company’s proprietary discovery and drug development platform, PRISM. A copy of the press release is attached as Exhibit 99.2 to this Form 8-K and is incorporated by reference herein.

The information set forth in Exhibit 99.2, other than the second and third paragraphs thereof, is incorporated by reference into this Item 8.01 of this Current Report on Form 8-K.

Item 9.01 Financial Statements and Exhibits.

(d) Exhibits

Exhibit No.	Description
99.1	Corporate Presentation of Wave Life Sciences Ltd. dated January 11, 2021
99.2	Press Release issued by Wave Life Sciences Ltd. dated January 11, 2021
104	Cover Page Interactive Data File (embedded within the Inline XBRL document)

SIGNATURES

Pursuant to the requirements of the Securities Exchange Act of 1934, the registrant has duly caused this report to be signed on its behalf by the undersigned hereunto duly authorized.

WAVE LIFE SCIENCES LTD.

By: /s/ Paul B. Bolno, M.D.

Paul B. Bolno, M.D.
President and Chief Executive Officer

Date: January 11, 2021



Wave Life Sciences
Corporate Presentation

January 11, 2021



Forward-looking statements

This document contains forward-looking statements. All statements other than statements of historical facts contained in this document, including statements regarding possible or assumed future results of operations, preclinical and clinical studies, business strategies, research and development plans, collaborations and partnerships, regulatory activities and timing thereof, competitive position, potential growth opportunities, use of proceeds and the effects of competition are forward-looking statements. These statements involve known and unknown risks, uncertainties and other important factors that may cause the actual results, performance or achievements of Wave Life Sciences Ltd. (the "Company") to be materially different from any future results, performance or achievements expressed or implied by the forward-looking statements. In some cases, you can identify forward-looking statements by terms such as "may," "will," "should," "expect," "plan," "aim," "anticipate," "could," "intend," "target," "project," "contemplate," "believe," "estimate," "predict," "potential" or "continue" or the negative of these terms or other similar expressions. The forward-looking statements in this presentation are only predictions. The Company has based these forward-looking statements largely on its current expectations and projections about future events and financial trends that it believes may affect the Company's business, financial condition and results of operations. These forward-looking statements speak only as of the date of this presentation and are subject to a number of risks, uncertainties and assumptions, including those listed under Risk Factors in the Company's Form 10-K and other filings with the SEC, some of which cannot be predicted or quantified and some of which are beyond the Company's control. The events and circumstances reflected in the Company's forward-looking statements may not be achieved or occur, and actual results could differ materially from those projected in the forward-looking statements. Moreover, the Company operates in a dynamic industry and economy. New risk factors and uncertainties may emerge from time to time, and it is not possible for management to predict all risk factors and uncertainties that the Company may face. Except as required by applicable law, the Company does not plan to publicly update or revise any forward-looking statements contained herein, whether as a result of any new information, future events, changed circumstances or otherwise.

Building a leading genetic medicines company



INNOVATIVE PLATFORM

- Stereopure oligonucleotides
- Novel backbone modifications (PN chemistry)
- Allele-selectivity
- Multiple modalities (silencing, splicing, ADAR editing)
- Strong IP position¹



FOUNDATION OF NEUROLOGY PROGRAMS

- Huntington's disease
- ALS / FTD
- Neuromuscular diseases
- Ataxias
- Parkinson's disease
- Alzheimer's disease



Wave's discovery and drug development platform



CLINICAL DEVELOPMENT EXPERTISE

- Multiple global clinical trials ongoing across eight countries
- Innovative trial designs



MANUFACTURING

- Established internal manufacturing capabilities to produce oligonucleotides at scale

WAVE[™]
LIFE SCIENCES

ALS: Amyotrophic lateral sclerosis; FTD: Frontotemporal dementia
¹stereopure oligonucleotides and novel backbone chemistry modifications

PRISM has unlocked novel and proprietary advances in oligonucleotide design

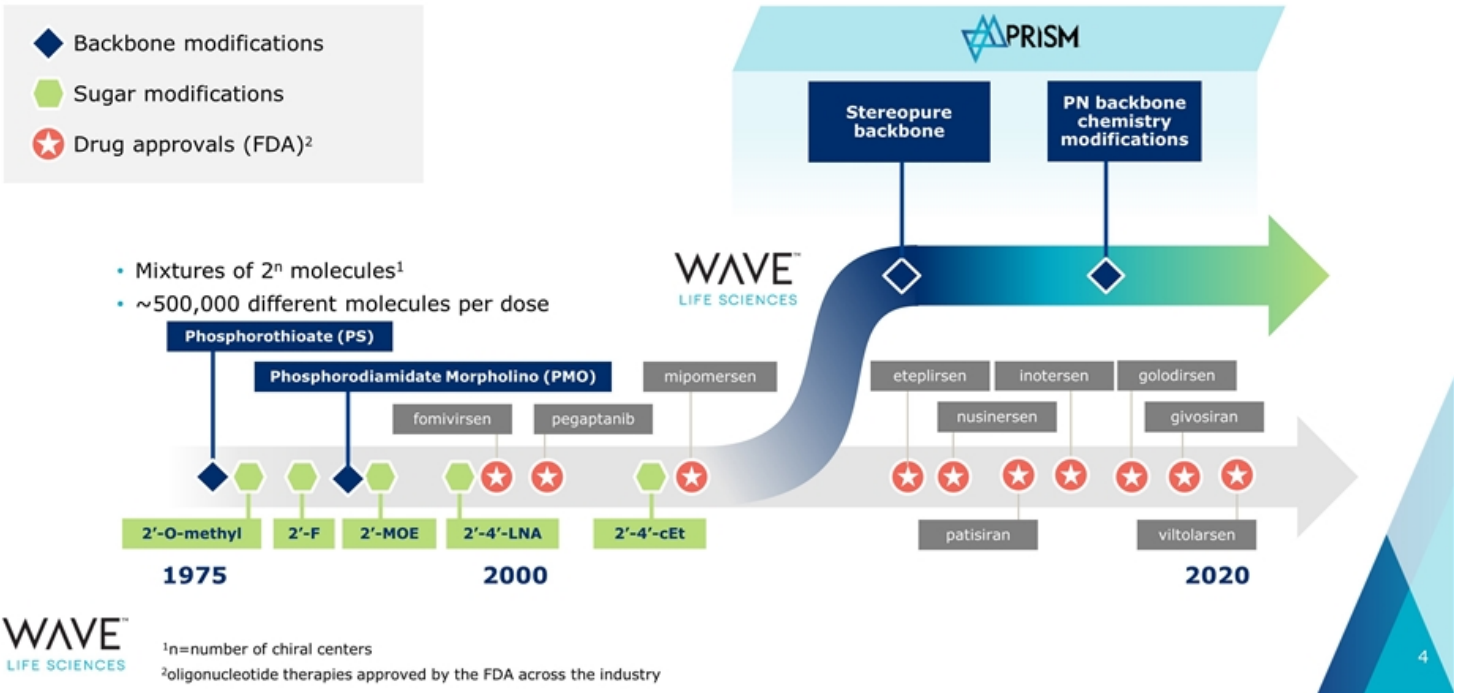

Innovative pipeline led by neurology programs

THERAPEUTIC AREA / TARGET	PRISM	DISCOVERY	PRECLINICAL	CLINICAL	PARTNER
NEUROLOGY					
Huntington's disease mHTT SNP1	◆	WVE-120101			Takeda 50:50 option
Huntington's disease mHTT SNP2	◆	WVE-120102			
Huntington's disease mHTT SNP3	◆ ◆	WVE-003			
ALS and FTD C9orf72	◆ ◆	WVE-004			
SCA3 ATXN3	◆ ◆				Takeda milestones & royalties
CNS diseases Multiple†	◆ ◆				
DMD Exon 53	◆ ◆	WVE-N531			100% global
ADAR editing Multiple	◆ ◆				
HEPATIC					
AATD (ADAR editing) SERPINA1	◆ ◆				100% global
OPHTHALMOLOGY					
Retinal diseases USH2A and RhoP23H	◆ ◆				100% global

WAVE™
LIFE SCIENCES

PRISM ◆ Stereopure ◆ PN chemistry

†During a four-year term, Wave and Takeda may collaborate on up to six preclinical targets at any one time.
ALS: Amyotrophic lateral sclerosis; FTD: Frontotemporal dementia; SCA3: Spinocerebellar ataxia 3; CNS: Central nervous system;
DMD: Duchenne muscular dystrophy; AATD: Alpha-1 antitrypsin deficiency



The logo for WAVE Life Sciences, featuring the word "WAVE" in a large, white, sans-serif font with a trademark symbol, and "LIFE SCIENCES" in a smaller, white, sans-serif font below it. The background is a dark blue triangle pointing downwards, set against a larger light blue triangle pointing upwards, creating a central white triangular space.

WAVE™
LIFE SCIENCES

WVE-120101
WVE-120102
WVE-003

Huntington's Disease Portfolio

Huntington's disease: a hereditary, fatal disorder

- Autosomal dominant disease, characterized by cognitive decline, psychiatric illness and chorea; fatal
- No approved disease-modifying therapies
- Expanded CAG triplet repeat in HTT gene results in production of mutant huntingtin protein (mHTT); accumulation of mHTT causes progressive loss of neurons in the brain
- Wild-type (healthy) HTT protein critical for neuronal function; evidence suggests wild-type HTT loss of function plays a role in Huntington's disease
- 30,000 people with Huntington's disease in the US; another 200,000 at risk of developing the condition

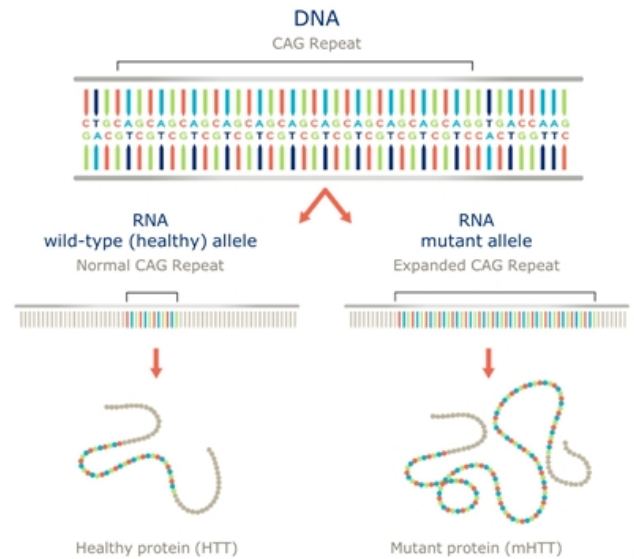

mHTT toxic effects lead to neurodegeneration, loss of wtHTT functions may also contribute to HD

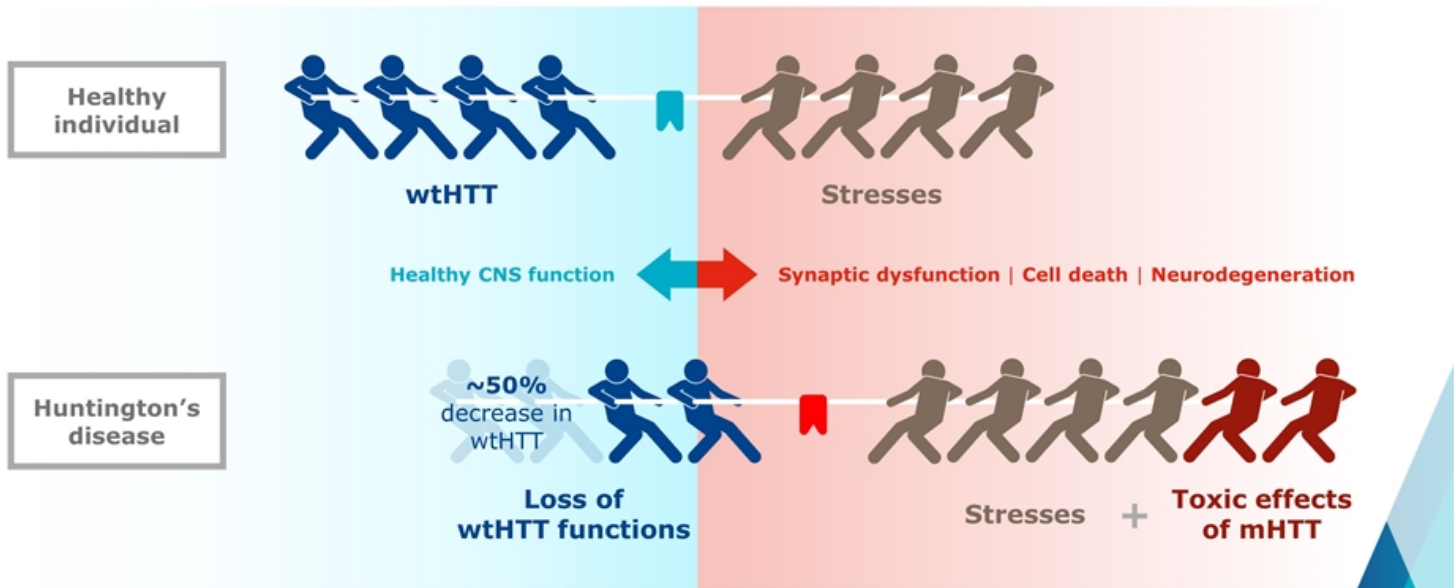

HD: Wild-type HTT is a critical protein for important functions in the central nervous system

NEURON



Promotes neuronal survival by protecting against stress (e.g., excitotoxicity, oxidative stress, toxic mHTT aggregates)¹⁻⁸

SYNAPSE



Plays an essential role in the transport of synaptic proteins—including neurotransmitters and receptors—to their correct location at synapses⁹⁻¹²

BRAIN CIRCUITS



Supplies BDNF to the striatum to ensure neuronal survival¹³⁻¹⁶
Regulates synaptic plasticity, which underlies learning and memory¹⁷⁻²²

CSF CIRCULATION



Plays a critical role in formation and function of cilia—sensory organelles that control the flow of CSF—which are needed to clear catabolites and maintain homeostasis²³

Nature publication contributes to weight of evidence on importance of wild-type huntingtin

nature

Article

Injured adult neurons regress to an embryonic transcriptional growth state

<https://doi.org/10.1038/s41586-020-2200-5>

Received: 12 April 2019

Accepted: 13 February 2020

Published online: 15 April 2020

[Check for updates](#)

Gunter H. D. Poplawski^{1,2}, Riki Kawaguchi^{1,2}, Erno Van Niekirk¹, Paul Li^{1,2}, Neil Mahata¹, Philip Canine¹, Richard Liu¹, Ioannis Dragatsis¹, Jessica M. Meiser¹, Binhai Zhang¹, Giovanni Coppola^{1,2} & Mark H. Tuszynski^{1,2}

Grafts of spinal-cord-derived neural progenitor cells (NPCs) enable the robust regeneration of corticospinal axons and restore forelimb function after spinal cord injury¹; however, the molecular mechanisms that underlie this regeneration are unknown. Here we perform translational profiling specifically of corticospinal tract (CST) motor neurons in mice, to identify their regenerative transcriptome after spinal cord injury and NPC grafting. Notably, both injury alone and injury combined with NPC grafts elicit virtually identical early transcriptional responses in host CST neurons. However, in mice with injury alone this regenerative transcriptome is downregulated after two weeks, whereas in NPC-grafted mice this transcriptome is sustained. The regenerative transcriptome represents a reversion to an embryonic transcriptional state of the CST neurons. The huntingtin gene (*htt*) is a central hub in the regenerative transcriptome; deletion of *htt* significantly attenuates regeneration, which shows that *htt* has a key role in neural plasticity after injury.

- Conditional knock-out of Htt in 4-month old mice (post-neuronal development)
- Results suggest that:
 - 1) Htt plays a central role in the regenerating transcriptome (potentially influencing genes such as NFκB, STAT3, BDNF)
 - 2) Htt is essential for regeneration

“Indeed, conditional gene deletion showed that Htt is required for neuronal repair. Throughout life, neuronal maintenance and repair are essential to support adequate cellular functioning”

WAVE[™]
LIFE SCIENCES

Source: Poplawski et al., *Nature*, April 2019
Htt: Huntingtin protein

WVE-120101: Selective reduction of mHTT mRNA and protein

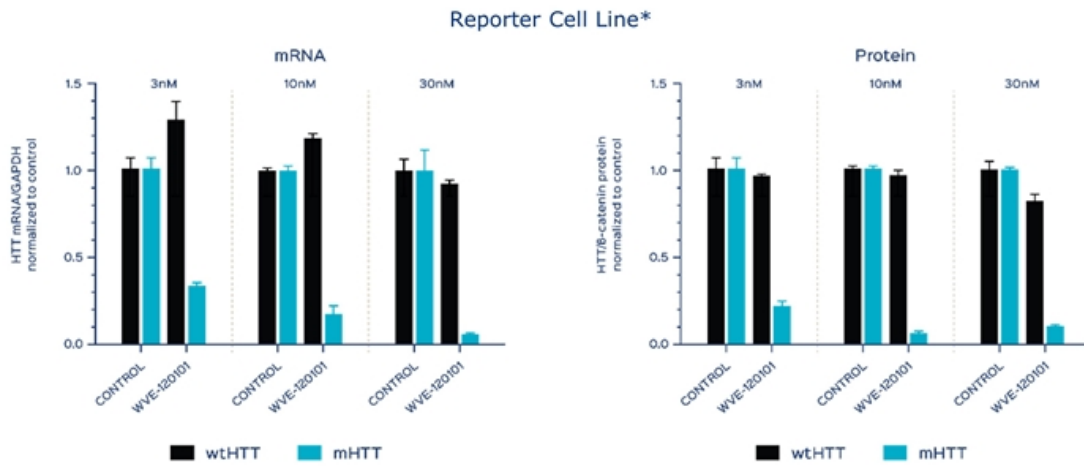

*These results were replicated in a patient-derived cell line

Demonstrated delivery to brain tissue

- WVE-120101 and WVE-120102 distribution in cynomolgus non-human primate brain following intrathecal bolus injection

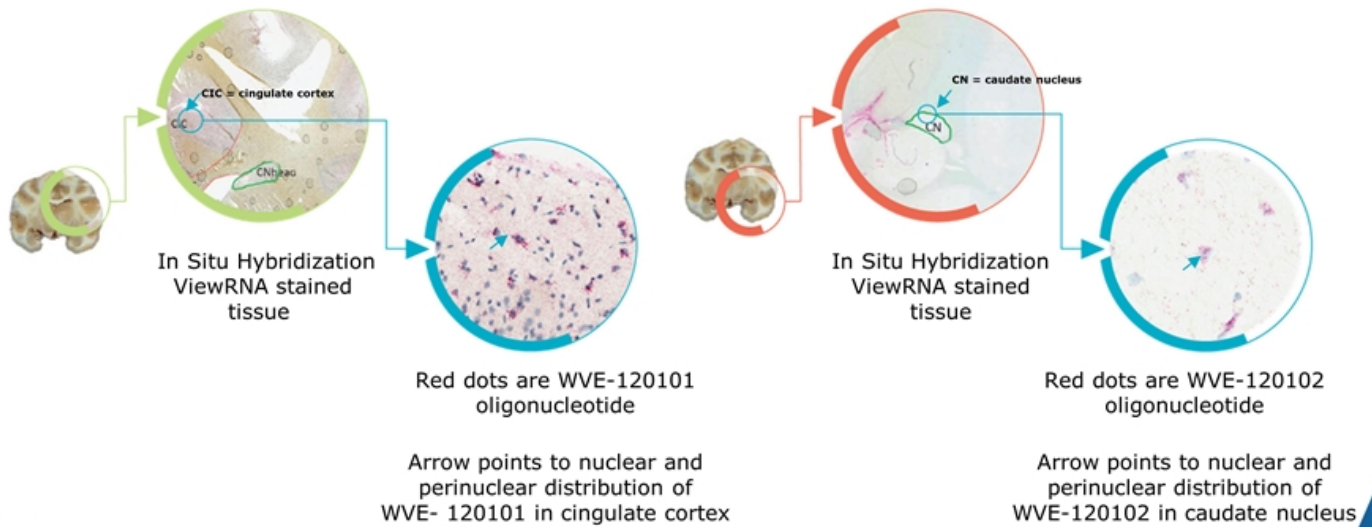

PRECISION-HD clinical trials

Two Phase 1b/2a clinical trials for WVE-120101 and WVE-120102

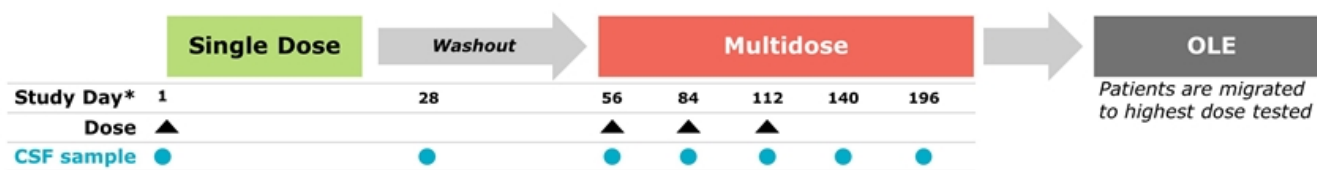

Trial results expected by end of 1Q 2021

- **PRECISION-HD1 and OLE** (including complete 16 mg cohort)
- **PRECISION-HD2 and OLE** (including complete 32 mg cohort)

Results

- **Safety and tolerability**
- **Biomarkers**
 - mHTT
 - tHTT
 - NFL
 - Assay development work to measure wtHTT in CSF ongoing



OLE: Open label extension; CSF: cerebrospinal fluid; mHTT: mutant huntingtin; wtHTT: wild-type HTT; tHTT: total HTT
 *Study day may vary depending on patient washout period

WVE-003 (SNP3) demonstrates selective, potent, and durable reduction of mHTT in preclinical models

Incorporates PN backbone chemistry modifications

Selectively reduces mHTT mRNA in HD iPSC neurons in vitro

Durable striatal mHTT knockdown for 12 weeks in BACHD mouse model

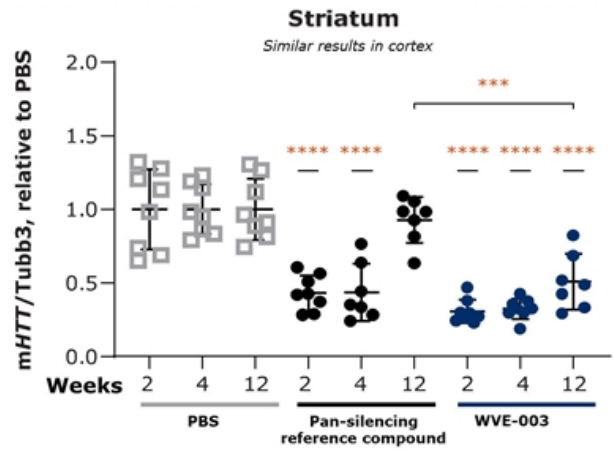
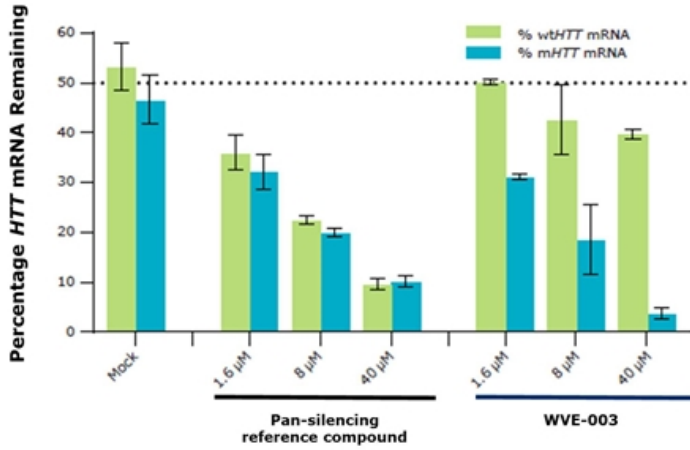

Clinical trial dosing expected to begin in 2021



Results from NDS0036 iPSC-derived medium spiny neurons. Total HTT knockdown quantified by qPCR and normalized to HPRT1 Oligonucleotide or PBS [100 μg ICV injections through a cannula on days 1, 3, and 5] delivered to BACHD transgenic. Mean ± SD (n=8, *P<0.0332, ***P<0.0002, ****P<0.0001 versus PBS unless otherwise noted). HPRT1, hypoxanthine-guanine phosphoribosyl transferase; iPSC, induced pluripotent stem cell; ICV, intracerebroventricular; PBS, phosphate-buffered saline

Three allele-selective HD programs

Potential to address ~80% of HD patient population

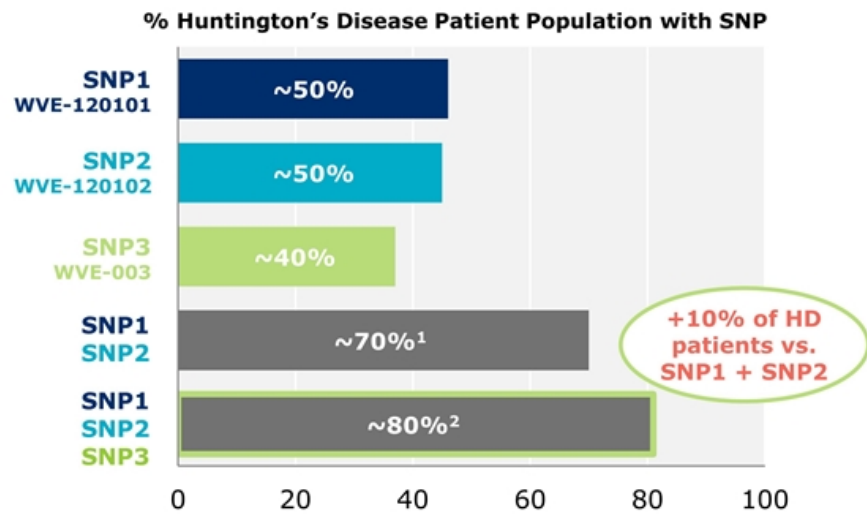

Intend to explore efficacy in early manifest and pre-manifest HD patient populations

¹ Percentage of patient population with SNP1 and/or SNP2

² Percentage of patient population with SNP1, SNP2 and/or SNP3

WVE-004

Amyotrophic Lateral Sclerosis (ALS)
Frontotemporal Dementia (FTD)

C9orf72 repeat expansions: A critical genetic driver of ALS and FTD

Normal (non-expanded) Allele

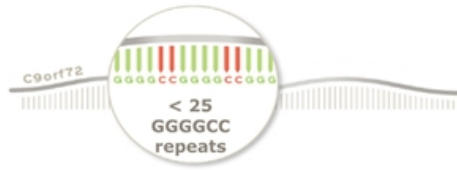

Expanded Allele



- C9orf72 hexanucleotide repeat expansions (GGGGCC) are one of the most common genetic causes of the sporadic and inherited forms of Amyotrophic Lateral Sclerosis (ALS) and Frontotemporal Dementia (FTD)
- The C9orf72 repeat expansions also lead to accumulation of repeat-containing transcripts, nuclear sequestration of RNA binding proteins and synthesis of toxic dipeptide-repeat (DPR) proteins
- The C9orf72 repeat expansions lead to reduced expression of wild-type C9orf72 and to cellular changes that reduce neuronal viability

C9-ALS and C9-FTD: Manifestations of a clinical spectrum

	Disease	C9 specific US population	Mean disease duration	Standard of care
C9-ALS	<ul style="list-style-type: none"> Fatal neurodegenerative disease Progressive degeneration of motor neurons in brain and spinal cord 	~2,000	3.1 years	Significant unmet need despite two approved therapies in US
C9-FTD	<ul style="list-style-type: none"> Progressive neuronal atrophy in frontal/temporal cortices Personality and behavioral changes, gradual impairment of language skills 	~10,000	6.4 years	No approved disease modifying therapies

Two devastating diseases with a shared genetic basis



ALS: Amyotrophic lateral sclerosis; FTD: Frontotemporal dementia
Sources: Cammack et al, Neurology, October 2019. Moore et al, Lancet Neurology, February 2020

C9orf72 repeat expansions: Mechanisms of cellular toxicity

- C9-ALS and C9-FTD may be caused by multiple factors:
 - Insufficient levels of C9orf72 protein
 - Accumulation of repeat-containing RNA transcripts
 - Accumulation of aberrantly translated DPR proteins
- Recent evidence suggests lowering C9orf72 protein exacerbates DPR-dependent toxicity

Variant-selective targeting could address multiple potential drivers of toxicity

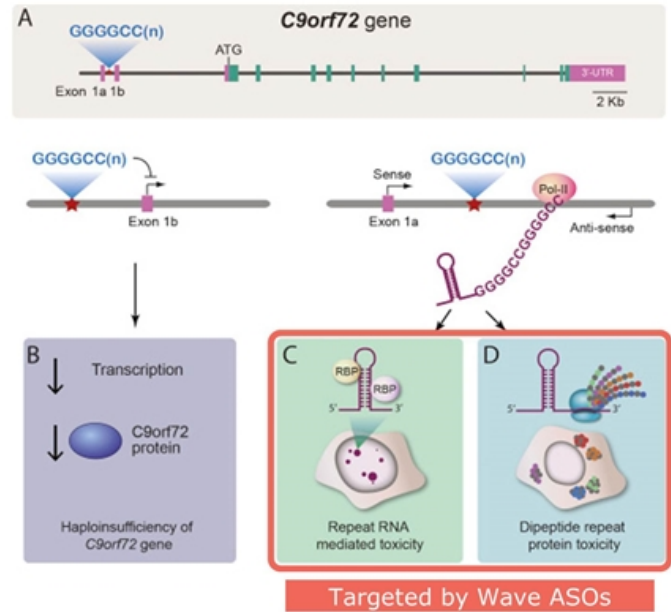

C9orf72 targeting strategy spares C9orf72 protein

- Normal C9orf72 allele produces three mRNA transcripts (~80% are V2, ~20% are V1 and V3)
- **Pathological allele** with expanded repeat leads to **healthy V2** and **pathological V1 and V3** transcript by-products

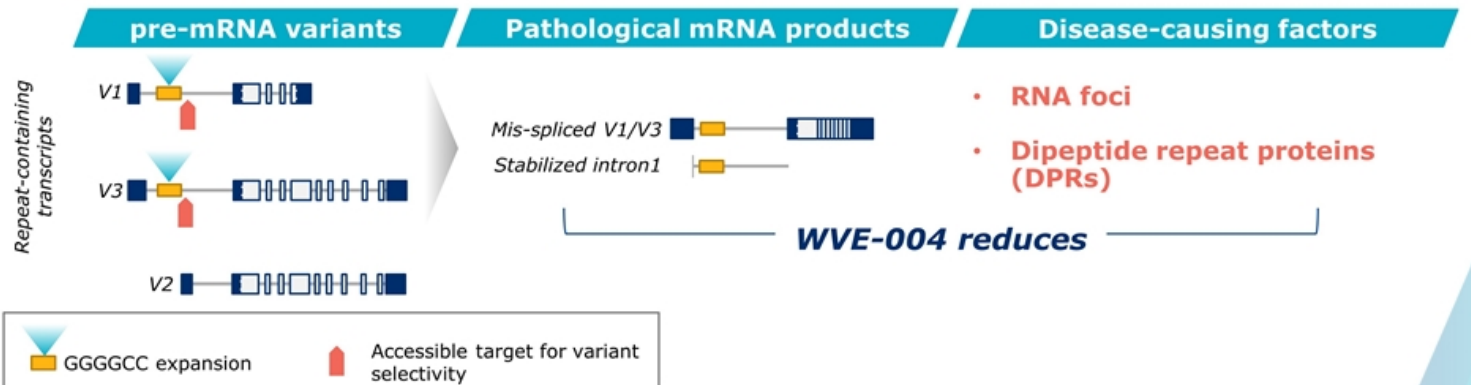

WVE-004 targets only V1 and V3 transcripts, sparing V2 transcripts and healthy C9orf72 protein

PN backbone chemistry modifications: Improved potency among C9orf72-targeting oligonucleotides *in vivo*

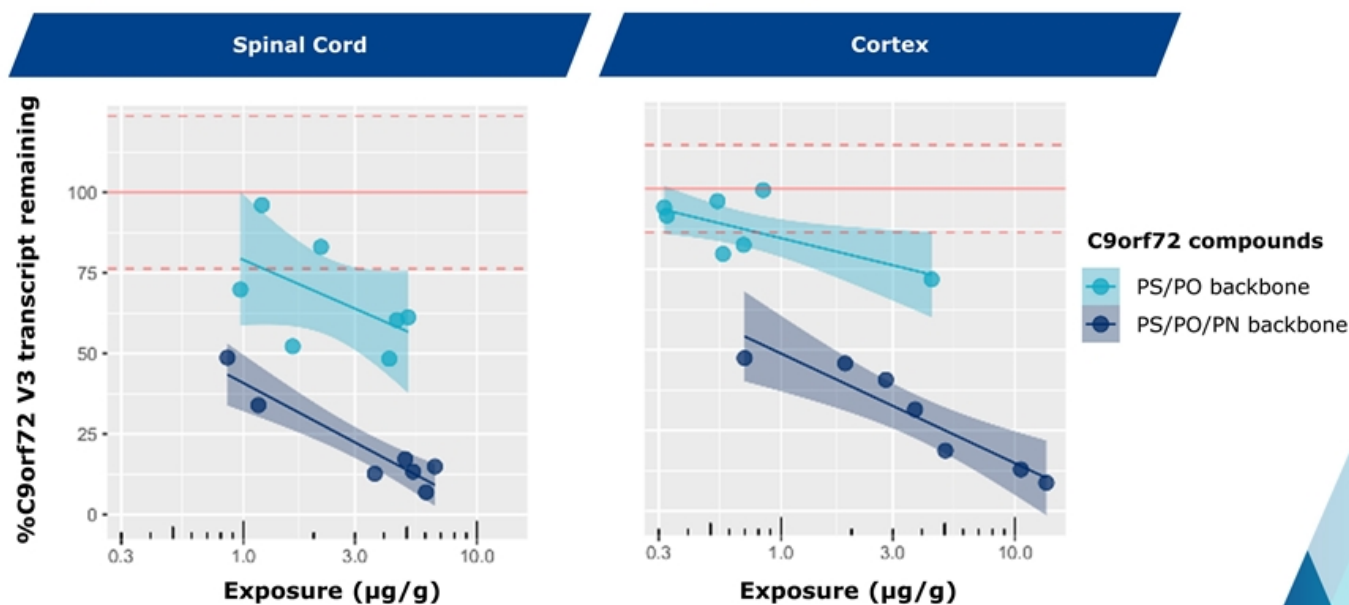

WVE-004: Potent and selective knockdown of repeat-containing transcripts *in vitro*

In vitro activity in C9 patient-derived neurons

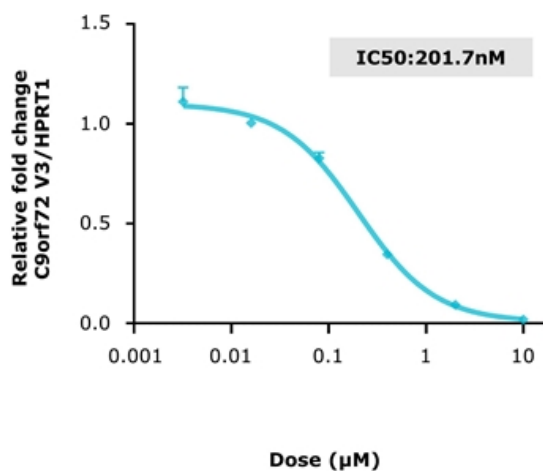

In vitro selectivity in C9 patient-derived neurons

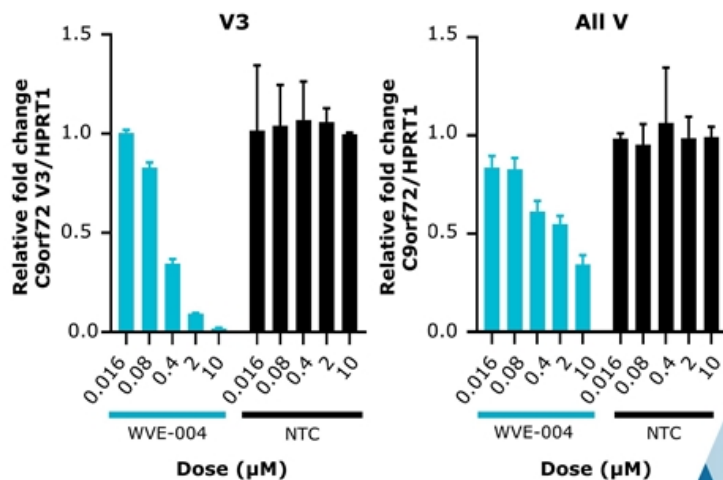

Durable knockdown of repeat transcripts *in vivo* after 6 months in spinal cord and cortex

Spinal cord

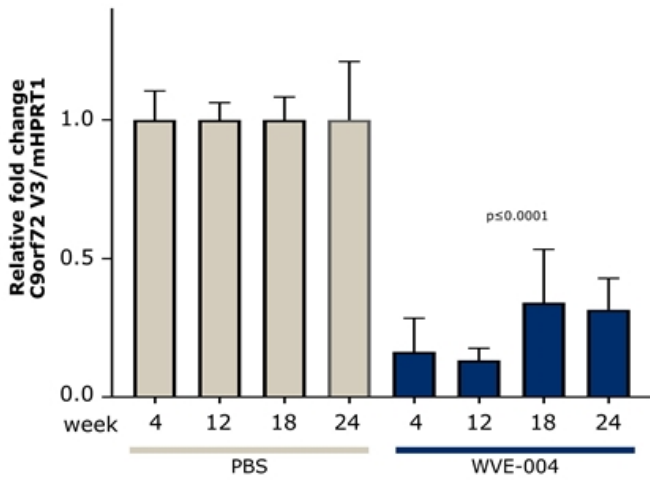

Cortex

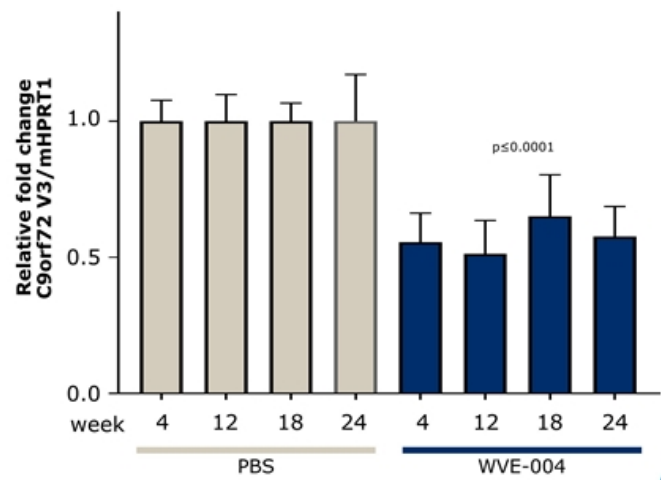

WVE-004 demonstrates durable reduction of DPRs *in vivo* after 6 months in spinal cord and cortex

Spinal cord

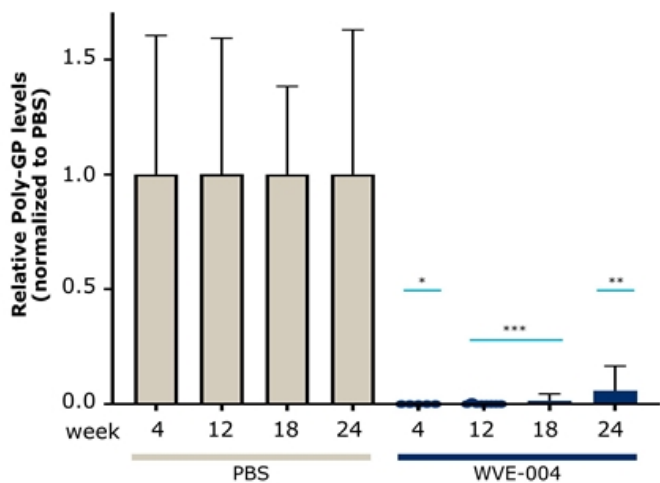

Cortex

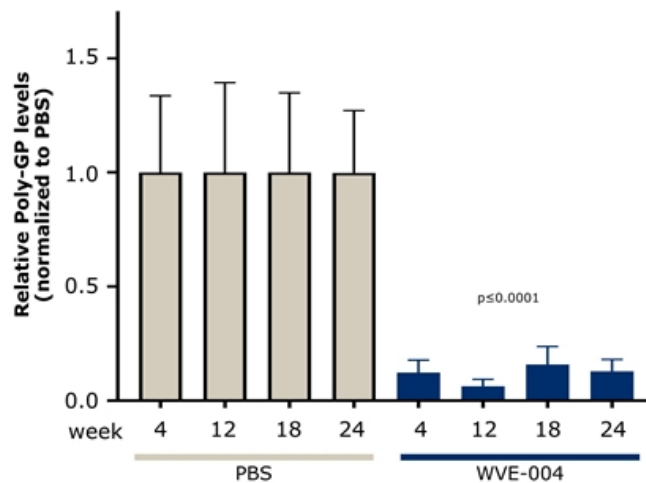

Experimental description: 2 x 50 ug on day 0 and day 7 dosed ICV; DPRs were measured by Poly-GP MSD assay.
 *: p ≤ 0.05 **; P ≤ 0.01, ***; P ≤ 0.001
 ICV: intracerebroventricular; Di-peptide repeat proteins: DPRs

Healthy C9 protein relatively unchanged ~6 months after WVE-004 administration

Spinal cord

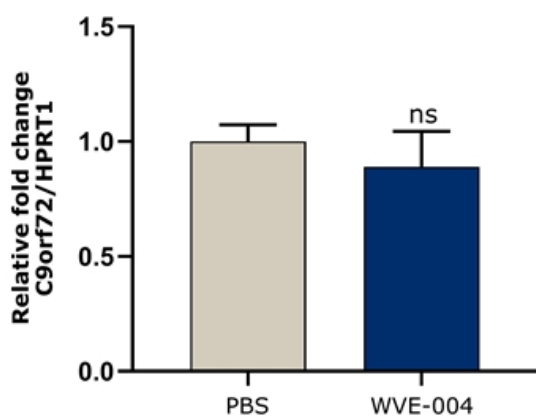

Cortex

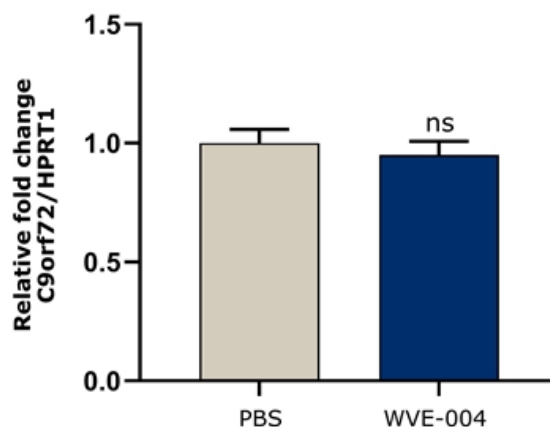

WVE-004 proof-of-concept study to include both ALS and FTD patients

- Patients with documented C9orf72 expansion and confirmed ALS or FTD diagnosis
- Single and multiple ascending doses to be explored
- Safety and tolerability
- Pharmacodynamic effects on key biomarkers while on treatment
 - PolyGP
 - NfL
- Key exploratory clinical outcome measures
 - ALSFRS-R and CDR-FTLD

Clinical trial dosing expected to begin in 2021

WVE-N531
Duchenne muscular dystrophy

WVE-N531 *in vitro* dose-dependent dystrophin restoration

Dystrophin protein restoration of up to 71%

Western Blot normalized to primary healthy human myoblast lysate

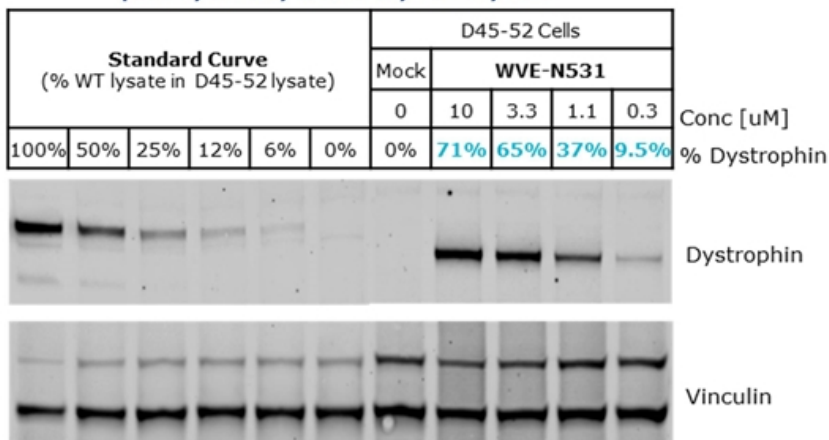

- WVE-N531 contains novel PN backbone chemistry modifications
- Free uptake for 6 days in differentiation media with no transfection agent and no peptide conjugated to the oligonucleotide
- Demonstrated a dose-dependent increase in dystrophin restoration in DMD patient-derived myoblasts



Experimental conditions: Δ45-52 (D45-52) patient myoblasts were treated with oligonucleotide for 6d under free-uptake conditions in differentiation media. Protein harvested in RIPA buffer and dystrophin restoration analyzed by Western Blot. Signal normalized to vinculin loading control and to primary healthy human myotube lysate (pooled from four donors) forming a standard curve in Δ45-52 cell lysate.

Substantial increase in survival observed in DKO model using PN chemistry (study ongoing)

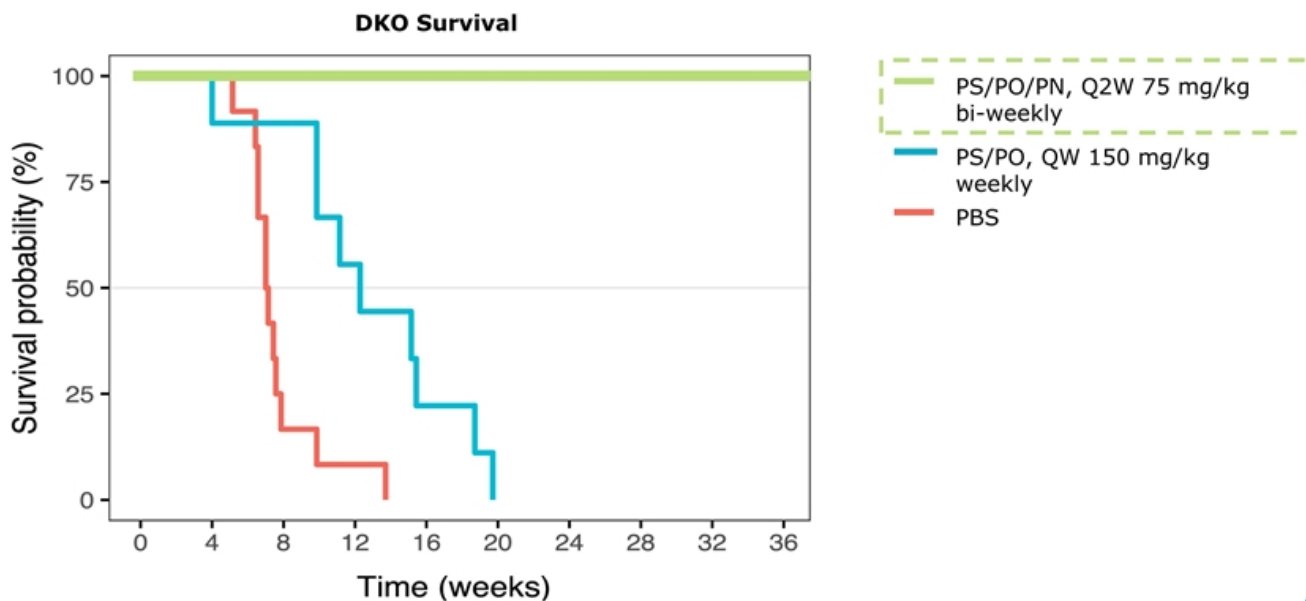

Planning underway for clinical trial investigating WVE-N531 in DMD

- DKO data and previously generated preclinical data support advancing WVE-N531 to the clinic
- Unmet need in DMD remains high
 - Support from DMD advocacy community to explore possibility to improve efficiency of exon skipping with novel therapeutic approaches such as PN chemistry
- Planned clinical trial adequately powered to evaluate change in dystrophin production, drug concentration in muscle, and initial safety
 - Open-label study; targeting every-other-week administration in up to 15 boys with DMD
 - Trial planned to be conducted in Europe
- Potential to apply PN chemistry to other exons if successful

CTA submission expected by end of 1Q 2021

WAVE[™]
LIFE SCIENCES



Wave's discovery and drug
development platform



Enables Wave to target genetically defined diseases with stereopure oligonucleotides across multiple therapeutic modalities

DESIGN

Unique ability to construct stereopure oligonucleotides with one defined and consistent profile

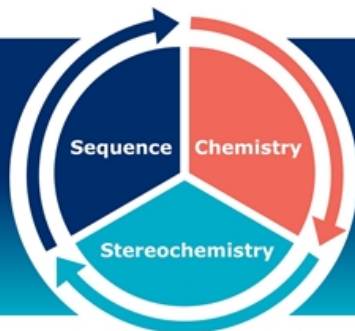

OPTIMIZE

A deep understanding of how the interplay among oligonucleotide sequence, chemistry, and backbone stereochemistry impacts key pharmacological properties

Through iterative analysis of *in vitro* and *in vivo* outcomes and machine learning-driven predictive modeling, Wave continues to define design principles that are deployed across programs to rapidly develop and manufacture clinical candidates that meet pre-defined product profiles

WAVE™
LIFE SCIENCES

Multiple modalities
Silencing | Splicing | ADAR editing

PRISM platform enables rational drug design

Sequence

B: bases

A, T, C, mC, G, U,
other modified bases

Stereochemistry

Chiral control of
any stereocenter

5' modifications,
backbone modifications

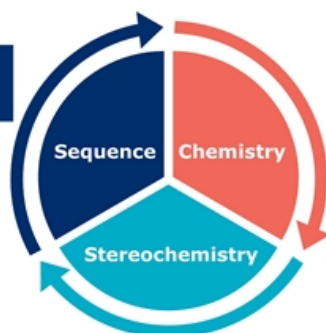

Chemistry

R: 2' modifications

OMe, MOE, F,
other modifications

X: backbone chemistry

Phosphodiester (PO),
phosphorothioate (PS),
Phosphoramidate diester
(PN)

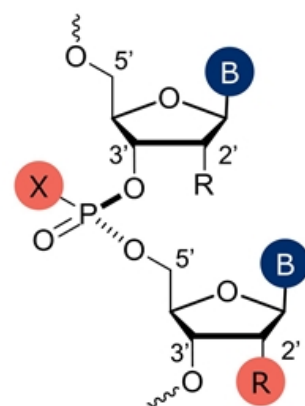

Expanding repertoire of backbone modifications with novel PN backbone chemistry



Backbone linkages

	PO	PS	PN
Backbone modification (X)	Phosphodiester 	Phosphorothioate 	Phosphoramidate diester
Stereochemistry	Not chiral	Chiral <ul style="list-style-type: none"> ◇ Stereorandom ▲ PS backbone Rp ▼ PS backbone Sp 	Chiral <ul style="list-style-type: none"> □ PN backbone Stereorandom ■ PN backbone Rp ▣ PN backbone Sp
Charge	Negative	Negative	Neutral
Depiction			
PRISM backbone modifications	PO/PS		PO/PS/PN

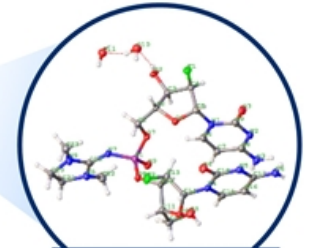

Phosphoryl guanidine x-ray structure

Rational design using PN backbone chemistry modifications increases *in vitro* potency in most cases

Silencing

In vitro knockdown of PS/PO containing compounds compared to PS/PN compounds with same sequence and PS stereochemistry

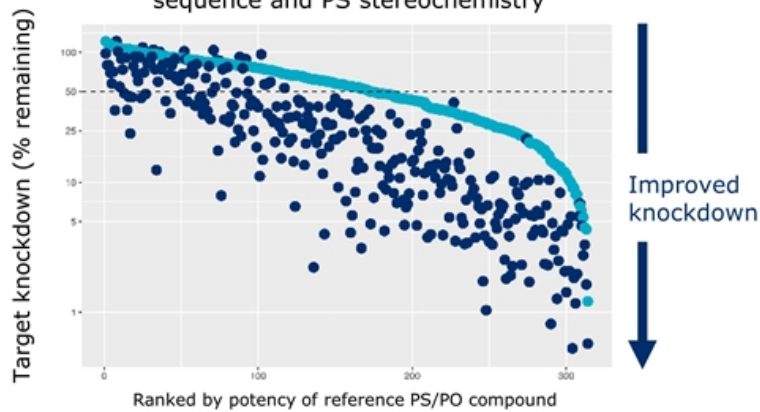

- PS/PO reference compound
- PS/PN modified compound

Splicing

In vitro skipping efficiency of PS/PO containing compounds compared to PS/PO/PN compounds with same sequence and PS stereochemistry

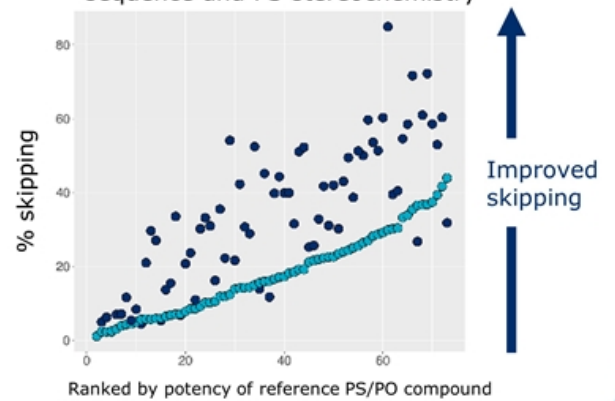

- PS/PO reference compound
- PS/PO/PN modified compound

Lead program in Takeda collaboration reinforces potential of PN chemistry in the CNS



Substantial and widespread target mRNA reduction following single intrathecal dose in NHPs

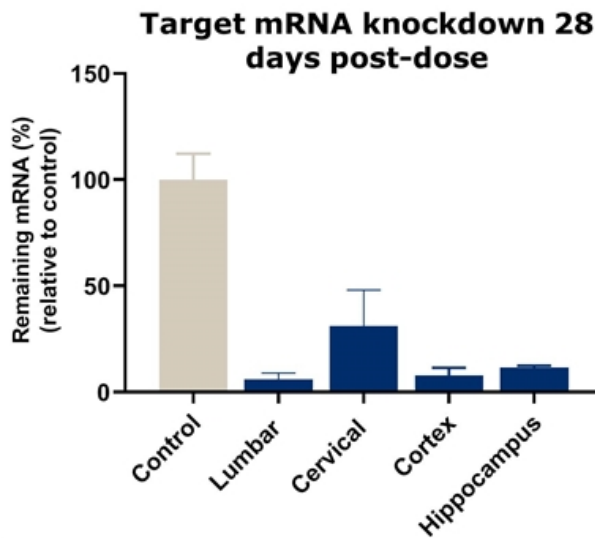

- Single IT dose of 12 mg (n=3)
- Therapeutic candidate widely distributed across brain and spinal cord
- ~90% mRNA knockdown one-month following single dose



NHPs: Non-human primates; IT: intrathecal
NHPs were administered 12 mg on day 1 via IT bolus injection; tissue samples were collected from 3 NHPs at 28 days post-dose.

PRISM enables optimal placement of backbone stereochemistry

Crystal structure confirms phosphate-binding pocket of RNase H binds 3'-SSR-5' motif in stereopure oligonucleotide – supports design strategy for Wave oligonucleotides

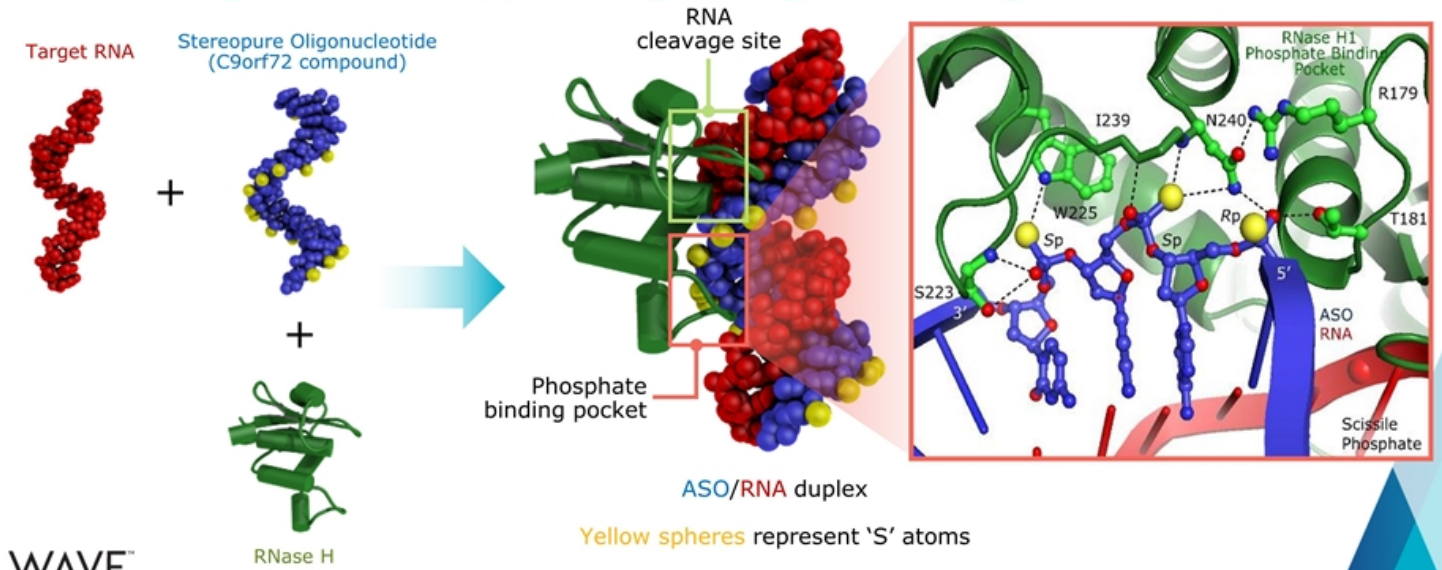

Importance of controlling stereochemistry

Stereochemical diversity

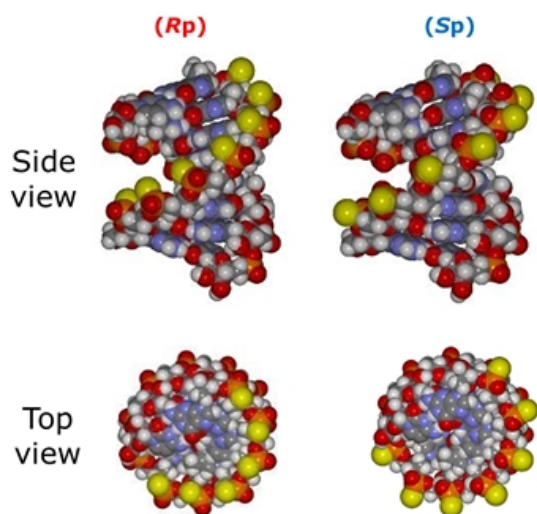

WAVE™

LIFE SCIENCES Yellow spheres represent 'S' atoms

PS: Phosphorothioate

Exponential diversity arises from uncontrolled stereochemistry

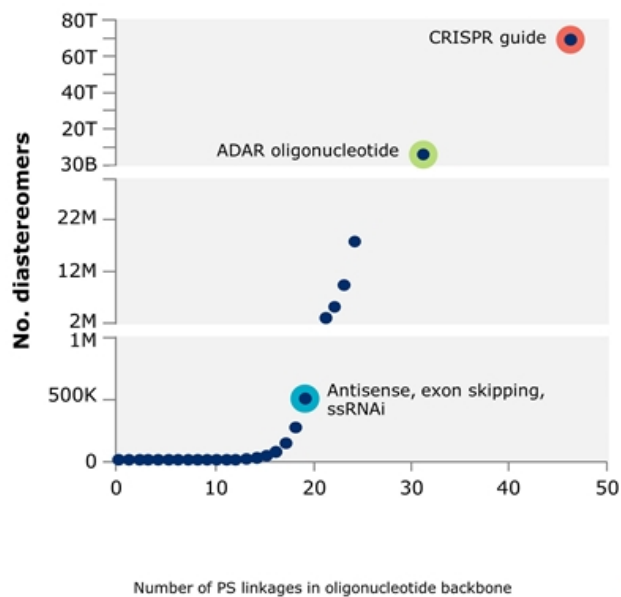

ADAR editing
Platform capability and
Alpha-1 antitrypsin deficiency

PRISM platform has unlocked ADAR editing

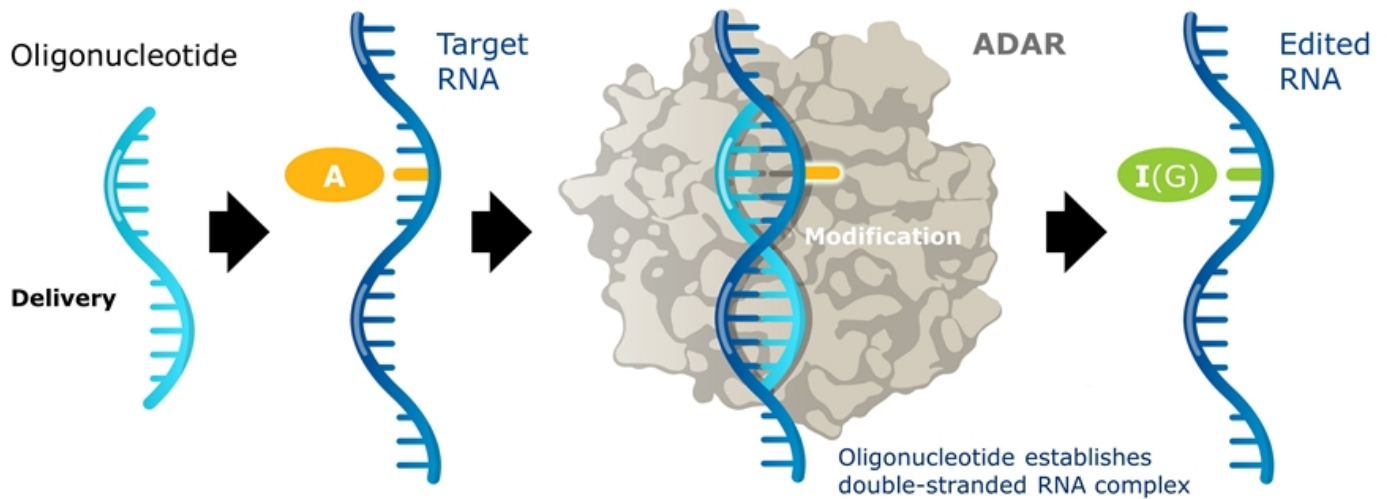

- **A-to-I** editing is one of most common post-transcriptional modifications
- ADAR is ubiquitously expressed across tissues, including liver and CNS

PRISM enables practical approach to RNA editing without need for viruses or exogenous protein

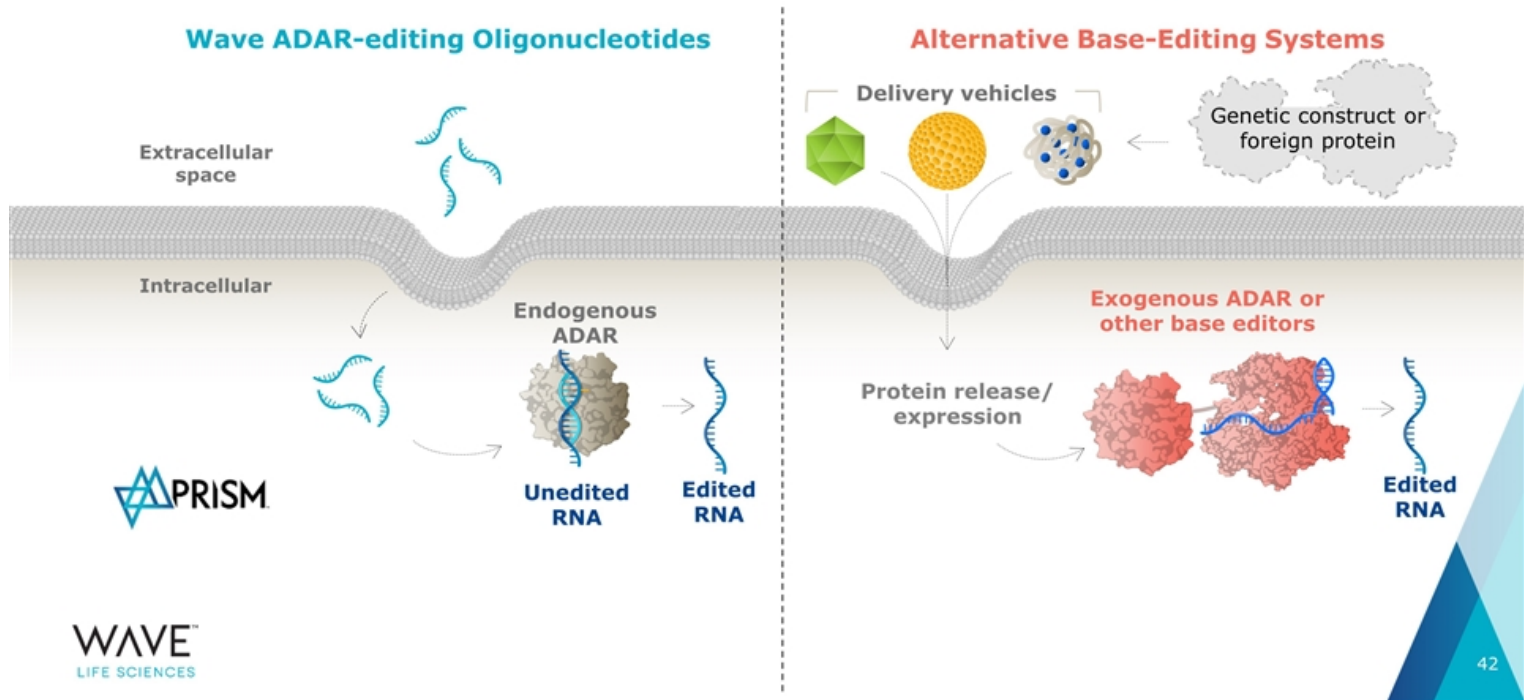

Advantages of Wave ADAR editing platform

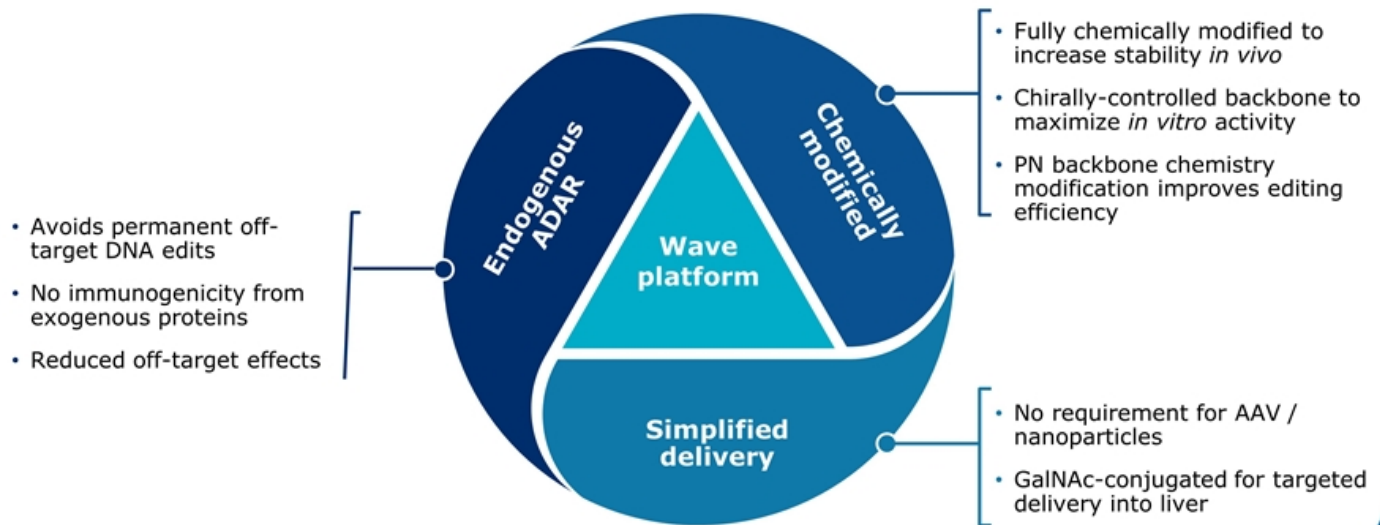

ADAR amenable diseases represent a sizeable opportunity

Potentially pathogenic human SNPs by base pair corrections

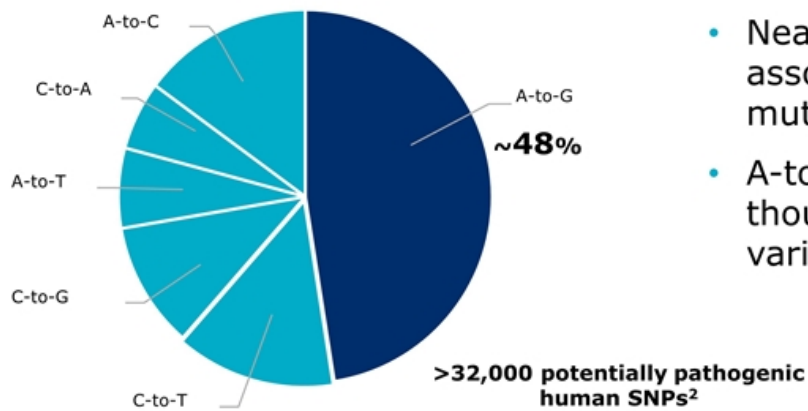

- Nearly half of known human SNPs associated with disease are G-to-A mutations
- A-to-I(G) editing could target tens of thousands of potential disease variants¹

RNA editing opens many new therapeutic applications

Restore protein function

- Fix nonsense and missense mutations that cannot be splice-corrected
- Remove stop mutations
- Prevent protein misfolding and aggregation

Examples:

Recessive or dominant genetically defined diseases

Modify protein function

- Alter protein processing (e.g. protease cleavage sites)
- Protein-protein interactions domains
- Modulate signaling pathways

Examples:

Ion channel permeability

Protein upregulation

- miRNA target site modification
- Modifying upstream ORFs
- Modification of ubiquitination sites

Examples:

Haploinsufficient diseases

PN chemistry improves editing efficiency

PN backbone chemistry modifications increased both potency and editing efficiency *in vitro*

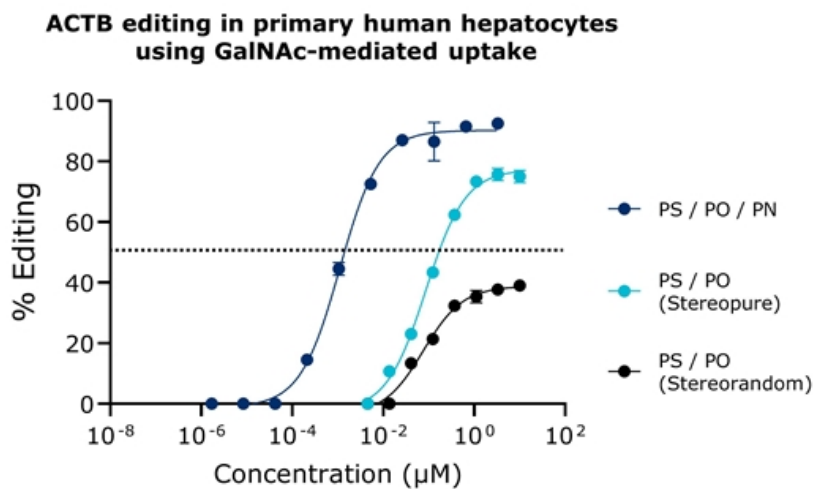

Significant ADAR editing demonstrated *in vitro* in NHP and primary human hepatocytes

ACTB GalNAc-conjugated oligonucleotides with stereopure PN backbone chemistry modifications

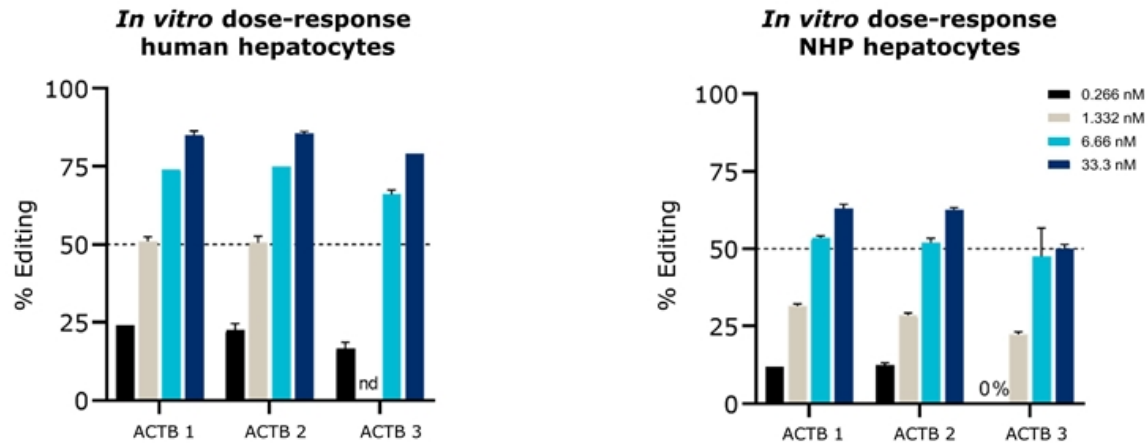

Efficient ADAR editing translated *in vivo* in non-human primate study

- Up to 50% editing efficiency observed at Day 7, 2 days post last dose
- Substantial and durable editing out to at least Day 50, 45 days post last dose

In vivo editing in NHP following subcutaneous administration

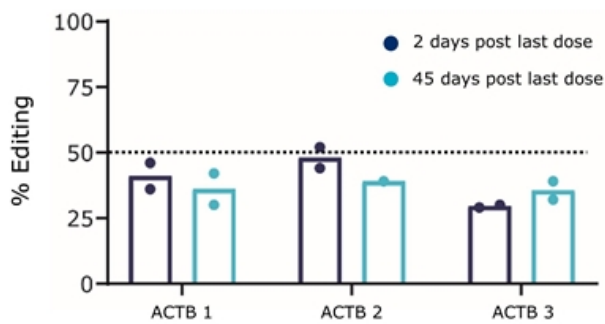

Oligonucleotide quantification in NHP following subcutaneous administration

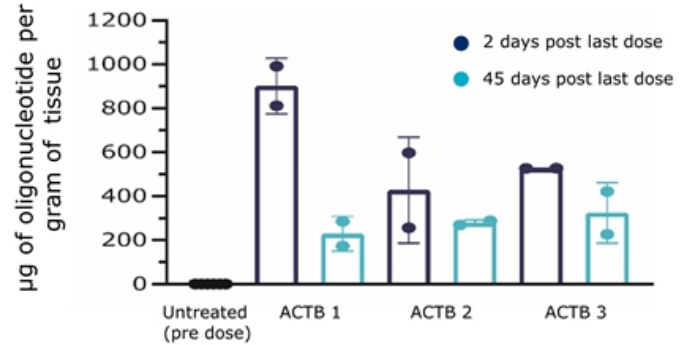

Wave ADAR editing oligonucleotides are highly specific

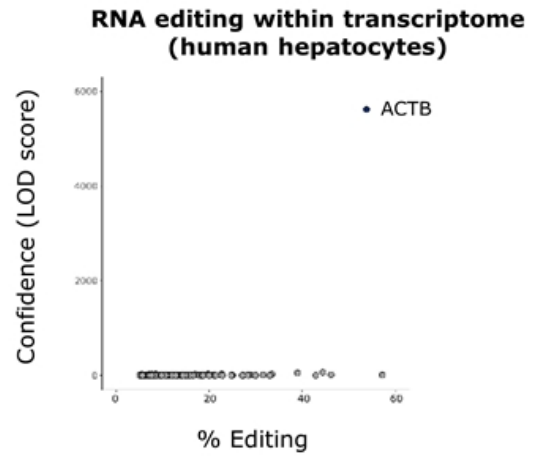
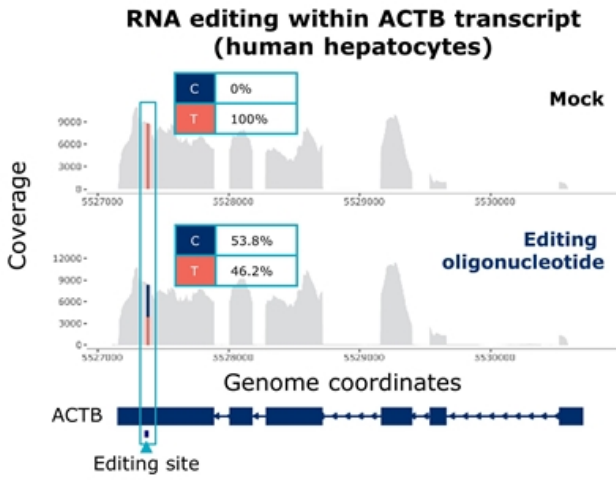

Advancing Wave's first ADAR editing program in alpha-1 antitrypsin deficiency (AATD)

- Most common cause is a single G-to-A point mutation on the "Z" allele
- ~**250K** people have the ZZ genotype, which is most severe
- Current approved therapies modestly increase circulating levels of AAT in those with lung pathology; no therapies address liver pathology

Wave's approach may simultaneously address lung and liver manifestations by using ADAR editing to correct the mutation:

- Increase circulating levels of wild-type AAT protein
- Reduce aggregation in the liver
- Retain AAT physiological regulation

Loss of function in lung

Lack of functional AAT in serum:

- Insufficient levels to counteract protease levels, e.g., neutrophil elastase
- Lung damage due to unchecked proteolytic activity and inflammation
- Other tissues may be affected (e.g. skin)



Gain of function in liver

Misfolding of AAT in hepatocytes:

- Inability to secrete AAT
- AAT polymerizes in liver
- Liver damage/cirrhosis

SERPINA1 RNA editing increases protein concentration *in vitro*

In primary hepatocyte Pi*Z cell model, editing the Z transcript back to wild-type restored native protein folding and secretion from hepatocytes

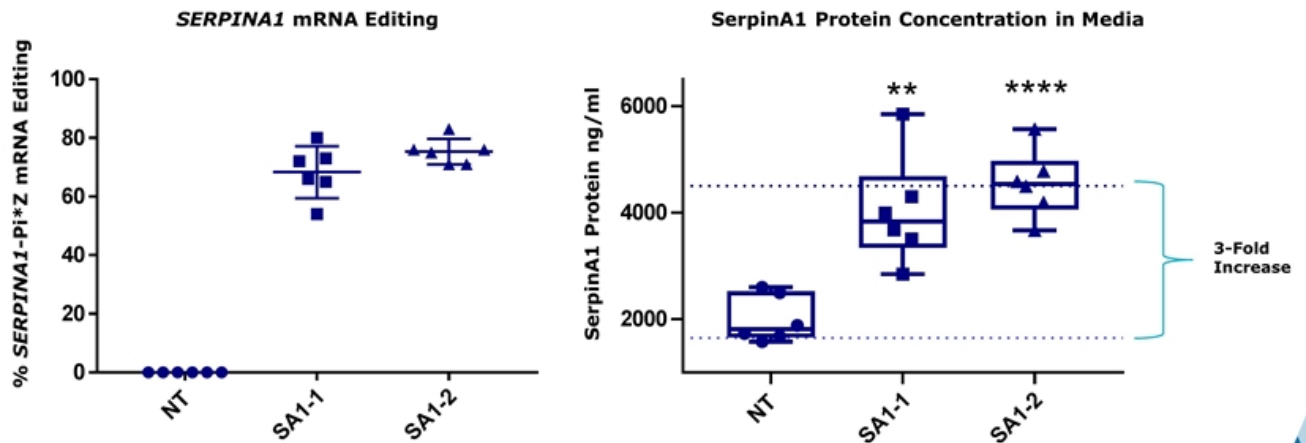

Proprietary humanized mouse model developed to support ADAR platform

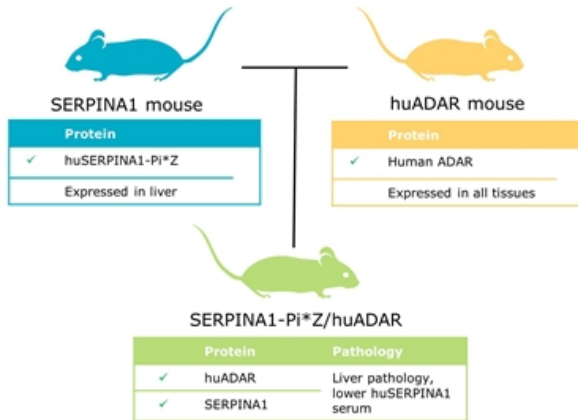

- Expression of huADAR in mouse is comparable to expression in human cells
- Expression of huADAR restores editing of endogenous targets in primary mouse cell types to levels seen in human primary cell types
- huADAR mouse model can be crossed with disease specific mouse models to provide model systems for use across Wave's ADAR editing programs

Model validation and *in vivo* data expected 1H 2021

Multiple opportunities for ADAR editing in neurology

ACTB editing in iCell Neurons

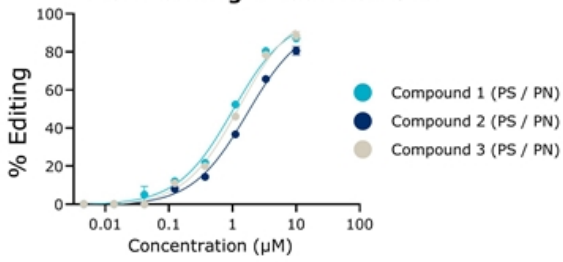

ACTB editing in human iCell Astrocytes

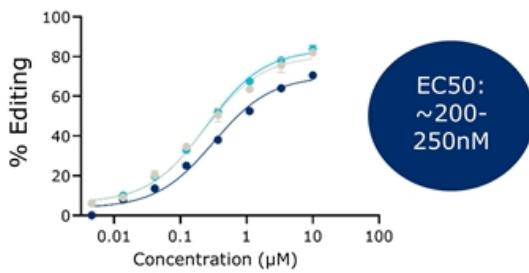

WAVE™
LIFE SCIENCES

Gymnotic uptake; Total RNA was harvested, reverse transcribed to generate cDNA, and the editing target site was amplified by PCR and quantified by Sanger sequencing

In vivo CNS editing in proprietary hADAR transgenic mouse (1 week)

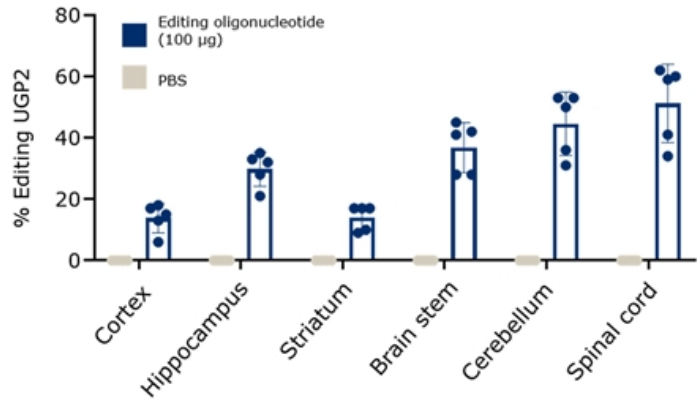

hADAR: human ADAR; UGP2: Glucose Pyrophosphorylase 2; 5 mice in each group were injected with PBS or a single 100µg dose on day 0. Animals were necropsied on day 7. RNA was harvested and editing measured by Sanger sequencing.

PRISM

The logo for WAVE LIFE SCIENCES is located in the top left corner. It features the word "WAVE" in a large, white, sans-serif font with a trademark symbol (TM) to its upper right. Below "WAVE" is the phrase "LIFE SCIENCES" in a smaller, white, sans-serif font. The background of the logo area is a dark blue triangle pointing downwards, which is part of a larger graphic design of overlapping triangles in various shades of blue and white.

WAVE™
LIFE SCIENCES

Ophthalmology

Stereopure oligonucleotides for inherited retinal diseases (IRDs)

Wave ophthalmology opportunity

- Oligonucleotides can be administered by intravitreal (IVT) injection; targeting twice per year dosing
- Stereopure oligonucleotides open novel strategies in both dominant and recessive IRDs; potential for potent and durable effect with low immune response

Successful targeting of *MALAT1* is a surrogate for an ASO mechanism of action

- Widely expressed in many different cell types
- Only expressed in the nucleus

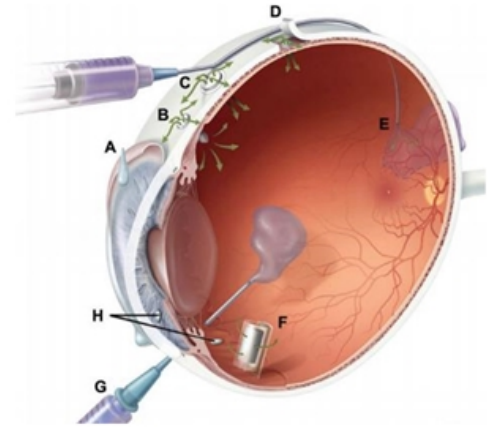

Intravitreal injection

Durable Malat1 knockdown through 9 months with PN backbone chemistry modifications

~50% Malat1 knockdown at 36 weeks in the posterior of the eye

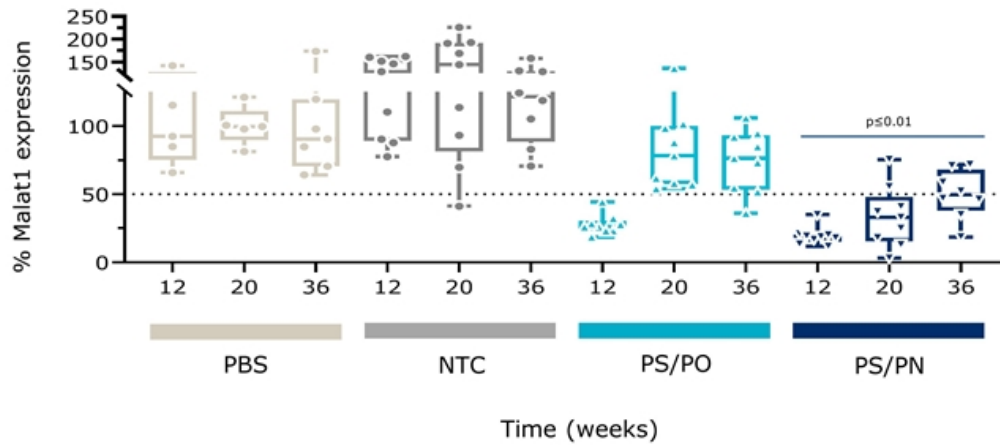

Usher Syndrome Type 2A: a progressive vision loss disorder

- Autosomal recessive disease characterized by hearing loss at birth and progressive vision loss beginning in adolescence or adulthood
- Caused by mutations in USH2A gene (72 exons) that disrupt production of usherin protein in retina, leading to degeneration of the photoreceptors
- No approved disease-modifying therapies
- **~5,000 addressable patients in US**

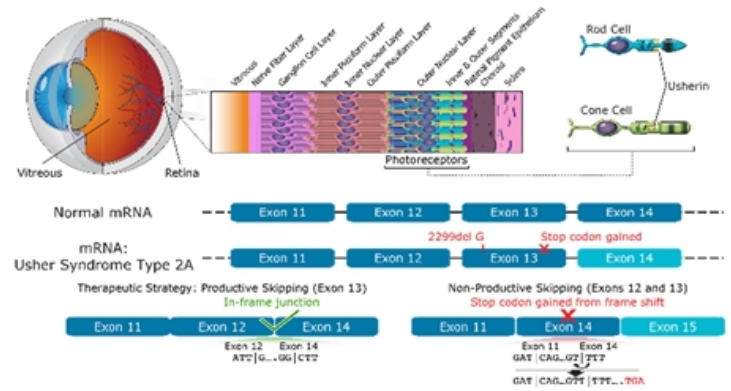

Oligonucleotides that promote USH2A exon 13 skipping may restore production of functional usherin protein

Potent USH2A exon 13 skipping with stereopure compound in *vitro* and *ex vivo*

Enhanced potency over a stereorandom reference compound (*in vitro*)

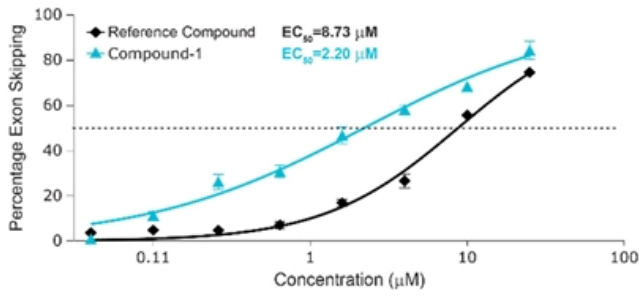

Target engagement in NHP and human retinas (*ex vivo*)

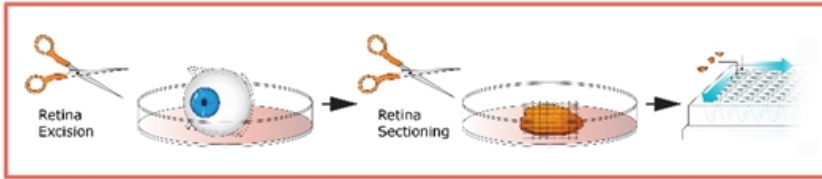
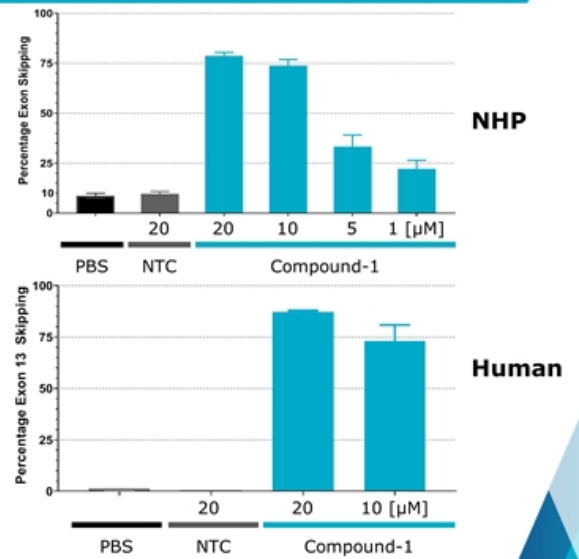

WAVE™
LIFE SCIENCES

Left: Compounds were added to Y79 cells under free-uptake conditions. Exon skipping was evaluated by Taqman assays. *USH2A* transcripts were normalized to *SRSF9*. Data are mean \pm s.d., n=2. Reference Compound: van Diepen *et al.* 2018. Antisense oligonucleotides for the treatment of eye disease, W02018055134A1. Compound-1 is a stereopure antisense oligonucleotide. Right: Whole NHP and human eyes were enucleated (n=4 and n=2, respectively) and compounds (1–20 μM) were added to extracted retinas under free-uptake conditions. Exon skipping was evaluated by 48 hrs later by Taqman assays on RNA. *USH2A* transcript levels were normalized to *SRSF9*. Data presented are mean \pm s.e.m.

Allele-selective reduction of SNP-containing allele for adRP associated with Rhodopsin P23H mutation

- **Retinitis pigmentosa (RP)**: group of rare, genetic eye disorders resulting in progressive photoreceptor cell death and gradual functional loss; currently no cure
- ~10% of US autosomal dominant RP cases are caused by the P23H mutation in the rhodopsin gene (RHO)
- Mutant P23H rhodopsin protein is thought to misfold and co-aggregate with wild-type rhodopsin, resulting in a gain-of-function or dominant negative effect in rod photoreceptor cells

Stereorandom

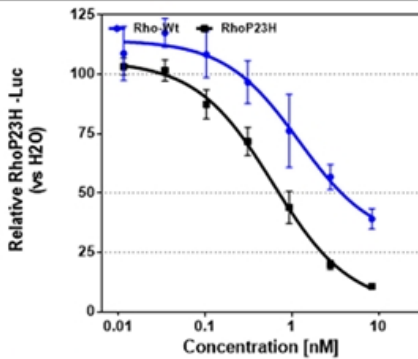

Stereopure

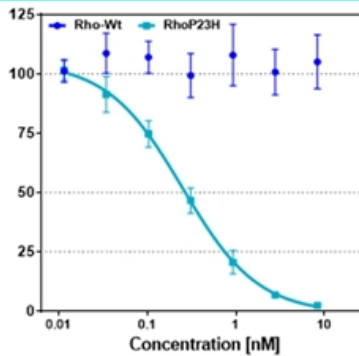

In vivo

Collaborations in place for evaluation in transgenic human Rho P23H pig model

Expected upcoming milestones

Therapeutic Area / Target



Milestone

NEUROLOGY

Huntington's disease mHTT SNP2		End of 1Q 2021: PRECISION-HD2 data, including complete 32 milligram cohort, and initial data from OLE trial
Huntington's disease mHTT SNP1		End of 1Q 2021: PRECISION-HD1 data, including complete 16 milligram cohort, and initial data from OLE trial
Huntington's disease mHTT SNP3		2021: Dosing of first patient in clinical trial of WVE-003
ALS and FTD C9orf72		2021: Dosing of first patient in clinical trial of WVE-004
Duchenne muscular dystrophy Exon 53		End of 1Q 2021: CTA submission
ADAR editing Multiple		1H 2021: Humanized mouse model validation

First clinical compounds with PN chemistry to begin dosing in 2021

HEPATIC

AATD (ADAR editing) SERPINA1		1H 2021: <i>in vivo</i> AATD data
---------------------------------	--	--



Stereopure

PN chemistry

WAVE™
LIFE SCIENCES

ALS: Amyotrophic lateral sclerosis; FTD: Frontotemporal dementia; SCA3: Spinocerebellar ataxia 3; AATD: Alpha-1 antitrypsin deficiency

WAVE™
LIFE SCIENCES

Realizing a
brighter future
for people
affected by
genetic diseases

For more information:

Kate Rausch, Investor Relations
krausch@wavelifesci.com
617.949.4827





Wave Life Sciences Highlights Pipeline Progress and Expansion Leveraging New PN Backbone Chemistry Modifications

Three clinical trials to begin in 2021 with compounds containing Wave's novel PN backbone chemistry modifications

Data from ongoing PRECISION-HD and OLE clinical trials for Huntington's disease expected by end of 1Q 2021

Potential best-in-class ADAR editing platform capability continues to advance, with validation of proprietary in vivo modeling system and delivery of in vivo alpha-1 antitrypsin deficiency data expected 1H 2021

CAMBRIDGE, Mass., January 11, 2021 – Wave Life Sciences Ltd. (Nasdaq: WVE), a clinical-stage genetic medicines company committed to delivering life-changing treatments for people battling devastating diseases, today announced key upcoming milestones for 2021, including the initiation of new clinical trials, expected data readouts, and continued advancement of Wave's proprietary discovery and drug development platform, PRISM™.

"2020 was a year of focused and formative progress for Wave, which culminated with submissions of clinical trial applications for two new programs. We continued to deliver on our ambitious goals despite the pandemic and are now on a course to unlock significant value from our pipeline and platform starting in 2021. Our research and clinical teams have made impressive headway across our portfolio of investigational stereopure oligonucleotides, and today we are advancing more than a dozen silencing, splicing and editing programs across various stages of development," said Paul Bolno, MD, MBA, President and Chief Executive Officer of Wave Life Sciences. "This year, we plan to initiate clinical trials for three compounds containing PN backbone chemistry modifications, which have been shown preclinically to increase potency, exposure and durability across various modalities. With our three new trials, we'll be able to more fully assess the potential of this novel chemistry advancement for the field of genetic medicine. They also offer the opportunity to deepen our impact in Huntington's disease and extend our research to others struggling with amyotrophic lateral sclerosis, frontotemporal dementia, and neuromuscular diseases."

"We also plan to deliver comprehensive data results from the ongoing PRECISION-HD trials late in the first quarter to enable a decision regarding potential Phase 3 development for WVE-120101 and WVE-120102, our first-generation Huntington's disease candidates. Lastly, we continue to invest in PRISM and look forward to contributing new findings in oligonucleotide design and delivery. Taken together, these advancements across our pipeline and platform are setting us up to become a leading genetic medicines company focused on delivering a new era of RNA therapeutics."

Advancing three clinical programs utilizing compounds containing Wave's novel PN backbone chemistry modifications to first-in-human studies: Wave expects to initiate dosing in three proof-of-concept studies in 2021, which will assess target engagement, impact on key disease biomarkers, and initial safety for WVE-003 in Huntington's disease (HD), WVE-004 in amyotrophic lateral sclerosis (ALS) and frontotemporal dementia (FTD), and WVE-N531 in Duchenne muscular dystrophy (DMD). All three compounds have novel designs incorporating PN backbone chemistry modifications, an advancement from Wave's PRISM platform.

WVE-003 for HD: WVE-003 is Wave's first HD candidate to use PN backbone chemistry modifications and is designed to selectively target the mRNA transcript produced by the mutant allele of the *huntingtin* (mHTT) gene, while leaving the wild-type (wtHTT) protein relatively intact. While the primary driver of HD is believed to be a dominant gain of function in mHTT protein, the concurrent loss of function of wtHTT protein may also be an important component of the

pathophysiology of HD. A growing body of scientific evidence suggests that preserving as much of the essential wtHTT protein as possible is important for favorable health outcomes over a lifetime with the disease.

- In December 2020, Wave submitted a clinical trial application (CTA) for WVE-003. Wave expects to initiate dosing in HD patients with SNP3 in 2021.
- The WVE-003 program is leveraging learnings and clinical expertise gained through the ongoing Phase 1b/2a PRECISION-HD studies, as well as learnings in oligonucleotide design gained through the PRISM platform.

WVE-004 for ALS and FTD: WVE-004 is an investigational variant-selective silencing candidate designed to selectively target the transcript variants containing a hexanucleotide repeat expansion (G4C2) in the *C9orf72* gene, while sparing the healthy C9orf72 protein. G4C2 expansions are one of the most common genetic causes of the sporadic and inherited forms of ALS and FTD.

- In December 2020, Wave submitted a CTA for WVE-004. Wave expects to initiate dosing in ALS and FTD patients with G4C2 expansions in 2021.

WVE-N531 for DMD: Based on compelling preclinical data, Wave is advancing WVE-N531 to explore exon skipping in dystrophic muscle. WVE-N531 was developed as an investigational treatment for DMD in boys amenable to exon 53 skipping and will be Wave's first splicing candidate incorporating PN backbone chemistry modifications to be assessed in the clinic.

- Wave expects to submit a CTA for WVE-N531 by the end of the first quarter in 2021.

PRECISION-HD clinical trials in HD: The PRECISION-HD1 and PRECISION-HD2 Phase 1b/2a and open label extension (OLE) trials evaluating WVE-120101 and WVE-120102 (respectively) in HD are ongoing. WVE-120101 and WVE-120102 are investigational stereopure oligonucleotides designed to selectively target the mHTT mRNA transcript, thereby leaving the wtHTT protein relatively intact.

- The 32 mg cohorts added to both PRECISION-HD trials in 2020 are fully enrolled and dosing is underway in the multidose portions.
- At the end of the first quarter, Wave expects to report data from both PRECISION-HD trials as well as available data from both ongoing OLE trials. These data are expected to enable a decision regarding potential Phase 3 development.
 - The analysis of PRECISION-HD2 will be comprised of biomarker and safety data from all cohorts, including all patients from the 32 mg cohort.
 - The analysis of PRECISION-HD1 will be comprised of biomarker and safety data from all completed cohorts, including all patients from the 16 mg cohort. Due to clinical site restrictions related to the COVID-19 pandemic, the last two patients in the PRECISION-HD1 32 mg cohort are currently scheduled to complete dosing in March 2021.
- The OLE trials have been enrolling patients from PRECISION-HD2 since October 2019 and PRECISION-HD1 since February 2020. The vast majority of eligible patients from the PRECISION-HD trials have enrolled in the OLEs.
 - Patients in the PRECISION-HD OLEs have begun transitioning to the 32 mg doses.
 - PRECISION-HD2 patients have received up to 16 monthly doses of 8 or 16 mg of WVE-120102 in the OLE.
 - PRECISION-HD1 patients have received up to 9 monthly doses of 8 or 16 mg of WVE-120101 in the OLE.

ADAR-mediated RNA editing (ADAR editing) platform capability: Wave's novel RNA editing modality also incorporates PN backbone chemistry modifications and uses endogenous ADAR (adenosine deaminases acting on RNA) enzymes via free uptake (non-viral, no nanoparticles) of A-to-I (G) RNA editing oligonucleotides. ADAR editing has the potential to unlock many new therapeutic applications, including restoration, modification or upregulation of proteins.

To support the advancement of best-in-class RNA editing candidates, Wave is developing a proprietary *in vivo* modeling system which crosses humanized ADAR mice with transgenic disease models. Wave expects to validate this modeling system in the first half of 2021.

SERPINA1 program for alpha-1 antitrypsin deficiency (AATD) with ADAR editing: In November 2020, Wave announced that its first ADAR editing program would be for AATD, which will target the G-to-A disease-causing mutation in mRNA coded by the *SERPINA1* Z allele. By correcting the single RNA base mutation, ADAR editing may provide an ideal approach for increasing circulating levels of wild-type AAT protein and reducing aggregation in the liver, thus simultaneously addressing both the lung and liver manifestations of the disease.

In a primary hepatocyte *SERPINA1* Z cell model, Wave demonstrated that editing the Z transcript back to wild-type restored native protein folding and secretion from hepatocytes. Wave expects to deliver *in vivo* data supporting the continued development of its AATD program in the first half of 2021.

Central nervous system (CNS) programs in collaboration with Takeda: Wave is leveraging learnings from PRISM to design additional stereopure oligonucleotides with optimized profiles for CNS indications, including in Alzheimer's disease, Parkinson's disease and others, as part of its ongoing collaboration with Takeda. Wave is utilizing PN backbone chemistry modifications to produce compelling *in vivo* data and progress multiple preclinical programs.

About Huntington's disease

Huntington's disease (HD) is a debilitating and ultimately fatal autosomal dominant neurological disorder, characterized by cognitive decline, psychiatric illness and chorea. HD causes nerve cells in the brain to deteriorate over time, affecting thinking ability, emotions and movement. HD is caused by an expanded cytosine-adenine-guanine (CAG) triplet repeat in the huntingtin (HTT) gene that results in production of mutant HTT (mHTT) protein. Accumulation of mutant HTT causes progressive loss of neurons in the brain. Wild-type, or healthy, HTT (wtHTT) protein is critical for neuronal function and suppression may have detrimental long-term consequences. Approximately 30,000 people in the United States have symptomatic HD and more than 200,000 others are at risk for inheriting the disease. There are currently no approved disease-modifying therapies available. Between Wave's three investigational molecules, the company has the potential to provide allele-selective therapeutic options for up to 80% of people with HD.

About amyotrophic lateral sclerosis and frontotemporal dementia

Amyotrophic lateral sclerosis (ALS) is a fatal, neurodegenerative disease in which the progressive degeneration of motor neurons in the brain and spinal cord leads to the inability to initiate or control muscle movement. People with ALS may lose the ability to speak, eat, move and breathe. ALS affects as many as 20,000 people in the United States.

Frontotemporal dementia (FTD) is a fatal, neurodegenerative disease in which progressive nerve cell loss in the brain's frontal lobes and temporal lobes leads to personality and behavioral changes, as well as the gradual impairment of language skills. It is the second most common form of early-onset dementia after Alzheimer's disease in people under the age of 65. FTD affects as many as 70,000 people in the United States.

ALS and FTD can be caused by mutations in the *C9orf72* gene, which provides instructions for making protein found in various tissues, including nerve cells in the cerebral cortex and motor neurons. In the U.S., mutations of the *C9orf72* gene are present in approximately 40% of familial ALS cases and 8% to 10% of sporadic ALS cases. In FTD, the mutations appear in 38% of familial cases and 6% of sporadic cases.

About Duchenne muscular dystrophy (DMD)

DMD is a fatal X-linked genetic neuromuscular disorder caused predominantly by out-of-frame deletions in the dystrophin gene, resulting in absent or defective dystrophin protein. Dystrophin protein is needed for normal muscle maintenance and operation. Because of the genetic mutations in DMD, the body cannot produce functional dystrophin, which results in progressive and irreversible loss of muscle function, including the heart and lungs. Worldwide, DMD affects approximately one in 5,000 newborn boys.

About PRISM™

PRISM is Wave Life Sciences' proprietary discovery and drug development platform that enables genetically defined diseases to be targeted with stereopure oligonucleotides across multiple therapeutic modalities, including silencing, splicing and editing. PRISM combines the company's unique ability to construct stereopure oligonucleotides with a deep

understanding of how the interplay among oligonucleotide sequence, chemistry and backbone stereochemistry impacts key pharmacological properties. By exploring these interactions through iterative analysis of *in vitro* and *in vivo* outcomes and machine learning-driven predictive modeling, the company continues to define design principles that are deployed across programs to rapidly develop and manufacture clinical candidates that meet pre-defined product profiles.

About Wave Life Sciences

Wave Life Sciences (Nasdaq: WVE) is a clinical-stage genetic medicines company committed to delivering life-changing treatments for people battling devastating diseases. Wave aspires to develop best-in-class medicines across multiple therapeutic modalities using PRISM, the company's proprietary discovery and drug development platform that enables the precise design, optimization and production of stereopure oligonucleotides. Driven by a resolute sense of urgency, the Wave team is targeting a broad range of genetically defined diseases so that patients and families may realize a brighter future. To find out more, please visit www.wavelifesciences.com and follow Wave on Twitter @WaveLifeSci.

Forward-Looking Statements

This press release contains forward-looking statements concerning our goals, beliefs, expectations, strategies, objectives and plans, and other statements that are not necessarily based on historical facts, including statements regarding the following, among others: the anticipated commencement, patient enrollment, data readouts and completion of our clinical trials, and the announcement of such events; the protocol, design and endpoints of our ongoing and planned clinical trials; the future performance and results of our programs in clinical trials; future preclinical activities and programs; regulatory submissions; the progress and potential benefits of our collaborations with partners; the potential of our *in vitro* and *in vivo* preclinical data to predict the behavior of our compounds in humans; our identification of future candidates and their therapeutic potential; the anticipated therapeutic benefits of our potential therapies, including our compounds containing PN chemistry, compared to others; our ability to design compounds using multiple modalities and the anticipated benefits of that model; the potential benefits of PRISM and our stereopure oligonucleotides compared with stereorandom oligonucleotides; the potential benefits of our novel ADAR-mediated RNA editing platform capabilities compared to others; and the benefit of nucleic acid therapeutics generally. Actual results may differ materially from those indicated by these forward-looking statements as a result of various important factors, including the following: our ability to finance our drug discovery and development efforts and to raise additional capital when needed; the ability of our preclinical programs to produce data sufficient to support our clinical trial applications and the timing thereof; the clinical results of our programs, which may not support further development of product candidates; actions of regulatory agencies, which may affect the initiation, timing and progress of clinical trials; our effectiveness in managing future clinical trials and regulatory interactions; the effectiveness of PRISM, including PN backbone chemistry modifications and ADAR editing; the effectiveness of our novel ADAR-mediated RNA editing platform capability; the continued development and acceptance of oligonucleotides as a class of medicines; our ability to demonstrate the therapeutic benefits of our candidates in clinical trials, including our ability to develop candidates across multiple therapeutic modalities; our dependence on third parties, including contract research organizations, contract manufacturing organizations, collaborators and partners; and competition from others developing therapies for similar indications, as well as the information under the caption "Risk Factors" contained in our most recent Annual Report on Form 10-K filed with the Securities and Exchange Commission (SEC) and in other filings we make with the SEC from time to time. We undertake no obligation to update the information contained in this press release to reflect subsequently occurring events or circumstances.

Investor Contact:

Kate Rausch
617-949-4827
krausch@wavelifesci.com

Media Contact:

Alicia Suter
617-949-4817
asuter@wavelifesci.com