

**UNITED STATES
SECURITIES AND EXCHANGE COMMISSION**
Washington, D.C. 20549

Form 8-K

**CURRENT REPORT
Pursuant to Section 13 or 15(d)
of the Securities Exchange Act of 1934**

Date of Report (Date of earliest event reported): March 4, 2021

WAVE LIFE SCIENCES LTD.

(Exact name of registrant as specified in its charter)

Singapore
(State or other jurisdiction
of incorporation)

001-37627
(Commission
File Number)

00-0000000
(IRS Employer
Identification No.)

**7 Straits View #12-00, Marina One
East Tower
Singapore**
(Address of principal executive offices)

018936
(Zip Code)

Registrant's telephone number, including area code: +65 6236 3388

Check the appropriate box below if the Form 8-K filing is intended to simultaneously satisfy the filing obligation of the registrant under any of the following provisions (see General Instruction A.2. below):

- Written communications pursuant to Rule 425 under the Securities Act (17 CFR 230.425)
- Soliciting material pursuant to Rule 14a-12 under the Exchange Act (17 CFR 240.14a-12)
- Pre-commencement communications pursuant to Rule 14d-2(b) under the Exchange Act (17 CFR 240.14d-2(b))
- Pre-commencement communications pursuant to Rule 13e-4(c) under the Exchange Act (17 CFR 240.13e-4(c))

Securities registered pursuant to Section 12(b) of the Act:

Title of each class	Trading symbol	Name of each exchange on which registered
\$0 Par Value Ordinary Shares	WVE	The Nasdaq Global Market

Indicate by check mark whether the registrant is an emerging growth company as defined in Rule 405 of the Securities Act of 1933 (§230.405 of this chapter) or Rule 12b-2 of the Securities Exchange Act of 1934 (§240.12b-2 of this chapter).

Emerging growth company

If an emerging growth company, indicate by check mark if the registrant has elected not to use the extended transition period for complying with any new or revised financial accounting standards provided pursuant to Section 13(a) of the Exchange Act.

Item 2.02 Results of Operations and Financial Condition.

On March 4, 2021, Wave Life Sciences Ltd. (the “Company”) announced its financial results for the quarter and year ended December 31, 2020. The full text of the press release issued in connection with the announcement is furnished as Exhibit 99.1 to this Current Report on Form 8-K and is incorporated by reference herein.

Item 7.01 Regulation FD Disclosure.

From time to time, the Company presents and/or distributes slides and presentations to the investment community to provide updates and summaries of its business. On March 4, 2021, the Company updated its corporate presentation, which is available on the “For Investors & Media” section of the Company’s website at <http://ir.wavelifesciences.com/>. This presentation is also furnished as Exhibit 99.2 to this Current Report on Form 8-K.

The information in these Items 2.02 and 7.01 are being furnished and shall not be deemed “filed” for purposes of Section 18 of the Securities Exchange Act of 1934, as amended (the “Exchange Act”), or otherwise subject to the liabilities of that Section, nor shall they be deemed incorporated by reference into any registration statement or other filing under the Securities Act of 1933, as amended, or the Exchange Act, except as shall be expressly set forth by specific reference in such filing.

Item 9.01 Financial Statements and Exhibits.

(d) Exhibits

The following exhibits relating to Items 2.02 and 7.01 are furnished and not filed:

Exhibit No.	Description
99.1	Press Release issued by Wave Life Sciences Ltd. dated March 4, 2021
99.2	Corporate Presentation of Wave Life Sciences Ltd. dated March 4, 2021
104	Cover Page Interactive Data File (embedded within the Inline XBRL document)

SIGNATURES

Pursuant to the requirements of the Securities Exchange Act of 1934, the registrant has duly caused this report to be signed on its behalf by the undersigned hereunto duly authorized.

WAVE LIFE SCIENCES LTD.

By: /s/ Paul B. Bolno, M.D.

Paul B. Bolno, M.D.

President and Chief Executive Officer

Date: March 4, 2021



Wave Life Sciences Reports Fourth Quarter and Full Year 2020 Financial Results and Provides Business Update

Strong execution in 2020 sets stage for advancing five clinical programs and novel ADAR editing modality in 2021

Data from ongoing PRECISION-HD and OLE clinical trials for Huntington's disease on track for end of 1Q 2021

Moving towards first patient dosing in three clinical trials with pipeline candidates incorporating PN chemistry: WVE-003 (SNP3), WVE-004 (C9orf72) and WVE-N531 (Exon 53)

Cash runway expected into 2Q 2023

Wave to host investor conference call and webcast at 8:00 a.m. ET today

CAMBRIDGE, Mass., Mar. 4, 2021 (GLOBE NEWSWIRE) — Wave Life Sciences Ltd. (Nasdaq: WVE), a clinical-stage genetic medicines company committed to delivering life-changing treatments for people battling devastating diseases, today announced financial results for the fourth quarter and full year ended December 31, 2020 and provided a business update.

“Wave is entering 2021 with depth and diversity throughout our pipeline and platform, the result of focused and deliberate execution, and a steadfast commitment to leading a new era of RNA therapeutics. Despite headwinds from the COVID-19 pandemic, we advanced our pipeline, significantly evolved our platform, announced our first ADAR editing program and added considerable talent to our innovative and driven team,” said Paul Bolno, MD, MBA, President and Chief Executive Officer of Wave Life Sciences. “We are poised to bring five clinical programs forward in 2021, including three programs in Huntington’s disease, a fourth program for ALS and FTD and a fifth program for exon 53 skipping in DMD. We remain on track to announce data from the Phase 1b/2a PRECISION-HD1 and PRECISION-HD2 trials at the end of the first quarter of 2021 and are excited about adding our next set of clinical programs incorporating novel PN backbone chemistry modifications, which preclinically have been shown to increase potency, exposure and durability in our growing portfolio of investigational stereopure oligonucleotides. Finally, we strengthened our balance sheet in September 2020 to support our pipeline and discovery work, extending our cash runway into the second quarter of 2023 and ensuring Wave is well-positioned to unlock potential and growth well beyond 2021.”

2020 Full Year and Recent Business Highlights and Upcoming Milestones

Three programs with novel PN backbone chemistry modifications expected to enter clinic in 2021:

- In August 2020, Wave introduced novel PN backbone chemistry modifications, an advancement from its PRISM™ discovery and drug development platform. In preclinical studies, these modifications have been shown to increase potency, exposure and durability across silencing, splicing and RNA editing modalities.
- Wave expects to initiate dosing in three clinical trials in 2021, which will assess target engagement, impact on key disease biomarkers, and initial safety of WVE-003 (targeting SNP3), WVE-004 (targeting C9orf72) and WVE-N531 (targeting exon 53).

- All three compounds were designed with PN backbone chemistry modifications, and insight from pharmacokinetic (PK) and pharmacodynamic (PD) studies using *in vivo* models, as well as learnings from Wave's first-generation programs.

Programs for Huntington's disease (HD): Wave is developing a unique portfolio of investigational stereopure oligonucleotides designed to selectively target the mutant allele of the *huntingtin* (mHTT) gene, while leaving the wild-type (wtHTT) protein relatively intact. Wave's approach to HD is guided by the recognition that, in addition to a gain of function of the mHTT protein, people with this disease have lost one copy of the wtHTT allele, leaving them with a smaller protective reservoir of healthy protein than unaffected individuals. A growing body of scientific evidence suggests that preserving as much of this essential protein as possible is important for favorable health outcomes. Wave's allele-selective approach may also enable treatment in the premanifest setting, before onset of clinical disease.

PRECISION-HD and OLE clinical trials in HD (WVE-120101 and WVE-120102):

- The PRECISION-HD1 and PRECISION-HD2 Phase 1b/2a trials evaluating investigational WVE-120101 (SNP1) and WVE-120102 (SNP2), respectively, in patients with HD are ongoing. WVE-120101 and WVE-120102 are designed to selectively target the mHTT mRNA transcript that contains specific single nucleotide polymorphisms (SNPs).
- Open-label extension (OLE) clinical trials for patients outside of the U.S. who participated in the Phase 1b/2a PRECISION-HD trials are also ongoing.
- Wave expects to report biomarker and safety data from all cohorts of the PRECISION-HD2 trial, along with data from all completed cohorts up to and including the 16 mg cohort from the PRECISION-HD1 trial at the end of the first quarter of 2021. Wave also expects to report data from patients who have received multiple doses of 8 or 16 mg of WVE-120101 or WVE-120102 in the OLE trials at the end of the first quarter of 2021.

WVE-003 (SNP3) for HD:

- WVE-003 is Wave's first allele-selective HD candidate that uses PN backbone chemistry modifications and was developed using preclinical *in vivo* models to enable target engagement assessment of a specific single nucleotide polymorphism (SNP3). In preclinical studies, WVE-003 showed selective reduction of mHTT mRNA *in vitro*, and potent and durable knockdown of mHTT mRNA *in vivo*.
- In December 2020, Wave initiated clinical development of WVE-003 with the submission of a clinical trial application (CTA).
- Wave expects to initiate dosing in a Phase 1b/2a clinical trial of WVE-003 for patients with HD in 2021.

Publications:

- In December 2020, in *Molecular Therapy Methods & Clinical Development*, Wave published its haplotype phasing method using single-molecule real-time sequencing and a custom algorithm to determine bases at SNPs on mutant alleles. Accurate haplotype phasing of SNPs and the expanded CAG repeat of the *huntingtin* gene enables identification of patients with Huntington's disease eligible for allele-selective clinical studies.
- In May 2020, Wave's prospective observational study of the frequency of SNP1 and SNP2 in patients with HD was published in *Neurology Genetics*. The study confirms the feasibility of rapidly and prospectively identifying SNP1 and/or SNP2 in association with the mHTT allele in patients with HD, to enable allele-selective, personalized treatment approaches in eligible patients.

WVE-004 (C9orf72) for amyotrophic lateral sclerosis (ALS) and frontotemporal dementia (FTD):

- In February 2021, Wave published in *Nature Communications* results of initial work to identify and validate its targeting strategy to achieve variant-selective knockdown of expansion-containing C9orf72 transcripts with stereopure oligonucleotides for the treatment of ALS and FTD. The results in the publication represent the foundational work that led to the development of Wave's clinical candidate, WVE-004, which uses PN backbone chemistry modifications.
- In December 2020, Wave initiated clinical development of WVE-004 with the submission of a CTA.

- In August 2020, Wave presented preclinical *in vivo* data for WVE-004, which demonstrated potent and durable knockdown of more than 90% of poly GP dipeptide repeat (DPR) protein in the spinal cord and at least 80% in the cortex, an effect that persisted for at least six months. Healthy C9orf72 protein was relatively unchanged over the same time period.
- Wave expects to initiate dosing in a Phase 1b/2a clinical trial of WVE-004 for both patients with C9-ALS and patients with C9-FTD in 2021.

WVE-N531 for Duchenne muscular dystrophy (DMD) amenable to exon 53 skipping:

- WVE-N531 is Wave's first splicing candidate to incorporate PN backbone chemistry modifications.
- In a recently completed *in vivo* study of double knock-out mice (a model lacking dystrophin and utrophin protein with a severe phenotype), an oligonucleotide designed with PN backbone chemistry modifications appeared to significantly increase dystrophin production and substantially improve survival.
- In a planned clinical trial, Wave will assess dystrophin production and initial safety in patients with DMD amenable to exon 53 skipping.
- Wave expects to submit a CTA for WVE-N531 by the end of the first quarter of 2021.

Central nervous system (CNS) programs in collaboration with Takeda:

- Wave is utilizing PN backbone chemistry modifications to design stereopure oligonucleotides for CNS indications, including Alzheimer's disease, Parkinson's disease and others, as part of its ongoing collaboration with Takeda. Wave continues to produce compelling *in vivo* data and progress multiple discovery programs towards portfolio entry and candidate nomination.
- In the fourth quarter of 2020, Wave achieved the first demonstration of widespread target engagement in the CNS of non-human primates (NHPs) for the most advanced therapeutic program in the collaboration. Approximately 90% knockdown of the target mRNA was observed one month after a single 12 mg intrathecal dose, and the therapeutic candidate distributed widely across relevant CNS tissues.

Alpha-1 antitrypsin deficiency (AATD) program with ADAR editing:

- Wave's AATD program, its first ADAR editing program, will target the G-to-A disease-causing mutation in mRNA coded by the *SERPINA1* Z allele. By correcting the single RNA base mutation, ADAR editing may provide an ideal approach for increasing circulating levels of wild-type alpha-1 antitrypsin (AAT) protein and reducing aggregation in the liver, thus simultaneously addressing both the lung and liver manifestations of the disease.
- In November 2020, Wave presented *in vitro* data in a primary hepatocyte *SERPINA1* Z allele cell model, which demonstrated that editing the Z transcript back to wild-type prevents protein misfolding and increases secretion of edited AAT protein from hepatocytes.
- Wave expects to deliver *in vivo* data supporting the continued development of its AATD program in the first half of 2021.

ADAR editing platform modality:

- Wave's novel RNA editing modality incorporates PN backbone chemistry modifications and uses endogenous ADAR (adenosine deaminases acting on RNA) enzymes via free uptake (non-viral, no nanoparticles) of A-to-I (G) RNA editing oligonucleotides. ADAR editing has the potential to unlock many new therapeutic applications, including restoration, modification or upregulation of proteins.

Fourth Quarter and Full Year 2020 Financial Results and Financial Guidance

Wave reported a net loss of \$28.8 million in the fourth quarter of 2020 as compared to \$56.8 million in the same period in 2019. The company reported a net loss of \$149.9 million for the year ended December 31, 2020 as compared to \$193.6 million for the year ended December 31, 2019.

Research and development expenses were \$30.0 million in the fourth quarter of 2020 as compared to \$49.1 million in the same period in 2019. Research and development expenses were \$130.9 million in 2020, as compared to \$175.4 million in 2019. The decrease in research and development expenses in the fourth quarter and full year was primarily due to the decrease in external expenses related to Wave's decision to discontinue its *suvodirsen* program in December 2019, as well as decreases in compensation-related expenses and other external expenses driven by Wave's February 2020 cost reduction plan, partially offset by the increases in external expenses related to Wave's clinical and preclinical activities related to its HD programs and its *C9orf72* program for ALS and FTD.

General and administrative expenses were \$9.7 million in the fourth quarter of 2020, as compared to \$13.8 million in the same period in 2019. General and administrative expenses were \$42.5 million in 2020, as compared to \$48.9 million in 2019. The decrease in general and administrative expenses in the fourth quarter and full year was primarily driven by the February 2020 cost reduction plan, which led to decreases in compensation-related expenses and other external expenses.

Wave ended 2020 with \$184.5 million in cash and cash equivalents as compared to \$147.2 million as of December 31, 2019. During 2020, Wave substantially extended its cash runway, largely by raising \$93.7 million in net proceeds from its September 2020 public offering and \$59.9 million in net proceeds from its at-the-market equity program.

Wave expects that its existing cash and cash equivalents, together with expected and committed cash from its existing collaboration, will enable the company to fund its operating and capital expenditure requirements into the second quarter of 2023.

Investor Conference Call and Webcast

Wave management will host an investor conference call today at 8:00 a.m. ET to discuss the company's fourth quarter and full year 2020 financial results and provide a business update. The conference call may be accessed by dialing (866) 220-8068 (domestic) or (470) 495-9153 (international) and entering conference ID: 6269069. The live webcast may be accessed from the investor relations section of the Wave Life Sciences corporate website at ir.wavelifesciences.com. Following the webcast, a replay will be available on the website.

About PRISM™

PRISM is Wave Life Sciences' proprietary discovery and drug development platform that enables genetically defined diseases to be targeted with stereopure oligonucleotides across multiple therapeutic modalities, including silencing, splicing and editing. PRISM combines the company's unique ability to construct stereopure oligonucleotides with a deep understanding of how the interplay among oligonucleotide sequence, chemistry and backbone stereochemistry impacts key pharmacological properties. By exploring these interactions through iterative analysis of *in vitro* and *in vivo* outcomes and machine learning-driven predictive modeling, the company continues to define design principles that are deployed across programs to rapidly develop and manufacture clinical candidates that meet pre-defined product profiles.

About Wave Life Sciences

Wave Life Sciences (Nasdaq: WVE) is a clinical-stage genetic medicines company committed to delivering life-changing treatments for people battling devastating diseases. Wave aspires to develop best-in-class medicines across multiple therapeutic modalities using PRISM, the company's proprietary discovery and drug development platform that enables the precise design, optimization and production of stereopure oligonucleotides. Driven by a resolute sense of urgency, the Wave team is targeting a broad range of genetically defined diseases so that patients and families may realize a brighter future. To find out more, please visit www.wavelifesciences.com and follow Wave on Twitter @WaveLifeSci.

Forward-Looking Statements

This press release contains forward-looking statements concerning our goals, beliefs, expectations, strategies, objectives and plans, and other statements that are not necessarily based on historical facts, including statements regarding the following, among others: the anticipated commencement, patient enrollment, data readouts and completion of our clinical trials, and the announcement of such events; the protocol, design and endpoints of our ongoing and planned

clinical trials; the future performance and results of our programs in clinical trials; future preclinical activities and programs; regulatory submissions; the progress and potential benefits of our collaborations with partners; the potential of our *in vitro* and *in vivo* preclinical data to predict the behavior of our compounds in humans; our identification of future product candidates and their therapeutic potential; the anticipated therapeutic benefits of our potential therapies compared to others; our ability to design compounds using multiple modalities and the anticipated benefits of that model; the anticipated benefits of our proprietary manufacturing processes and our internal manufacturing capabilities; the potential benefits of PRISM, including our novel PN backbone chemistry modifications, and our stereopure oligonucleotides compared with stereorandom oligonucleotides; the potential benefits of our novel ADAR-mediated RNA editing platform capabilities compared to others; the benefit of nucleic acid therapeutics generally; the strength of our intellectual property; the anticipated duration of our cash runway; and our expectations regarding the impact of the COVID-19 pandemic on our business. Actual results may differ materially from those indicated by these forward-looking statements as a result of various important factors, including the following: our ability to finance our drug discovery and development efforts and to raise additional capital when needed; the ability of our preclinical programs to produce data sufficient to support our clinical trial applications and the timing thereof; our ability to maintain the company infrastructure and personnel needed to achieve our goals; the clinical results of our programs, which may not support further development of product candidates; actions of regulatory agencies, which may affect the initiation, timing and progress of clinical trials; our effectiveness in managing future clinical trials and regulatory interactions; the effectiveness of PRISM, including our novel PN backbone chemistry modifications ; the effectiveness of our novel ADAR-mediated RNA editing platform capability; the continued development and acceptance of oligonucleotides as a class of medicines; our ability to demonstrate the therapeutic benefits of our candidates in clinical trials, including our ability to develop candidates across multiple therapeutic modalities; our dependence on third parties, including contract research organizations, contract manufacturing organizations, collaborators and partners; our ability to manufacture or contract with third parties to manufacture drug material to support our programs and growth; our ability to obtain, maintain and protect our intellectual property; our ability to enforce our patents against infringers and defend our patent portfolio against challenges from third parties; competition from others developing therapies for similar indications; the severity and duration of the COVID-19 pandemic and its negative impact on the conduct of, and the timing of enrollment, completion and reporting with respect to, our clinical trials; and any other impacts on our business as a result of or related to the COVID-19 pandemic, as well as the information under the caption "Risk Factors" contained in our most recent Annual Report on Form 10-K filed with the Securities and Exchange Commission (SEC) and in other filings we make with the SEC from time to time. We undertake no obligation to update the information contained in this press release to reflect subsequently occurring events or circumstances.

WAVE LIFE SCIENCES LTD.
UNAUDITED CONSOLIDATED BALANCE SHEETS
(In thousands, except share amounts)

	<u>December 31, 2020</u>	<u>December 31, 2019</u>
Assets		
Current assets:		
Cash and cash equivalents	\$ 184,497	\$ 147,161
Current portion of accounts receivable	30,000	20,000
Prepaid expenses	10,434	9,626
Other current assets	5,111	8,689
Total current assets	230,042	185,476
Long-term assets:		
Accounts receivable, net of current portion	—	30,000
Property and equipment, net	29,198	36,368
Operating lease right-of-use assets	16,232	18,101
Restricted cash	3,651	3,647
Other assets	115	10,658
Total long-term assets	49,196	98,774
Total assets	<u>\$ 279,238</u>	<u>\$ 284,250</u>
Liabilities, Series A preferred shares and shareholders' equity		
Current liabilities:		
Accounts payable	\$ 13,795	\$ 9,073
Accrued expenses and other current liabilities	11,971	16,185
Current portion of deferred revenue	91,560	89,652
Current portion of operating lease liability	3,714	3,243
Total current liabilities	121,040	118,153
Long-term liabilities:		
Deferred revenue, net of current portion	41,481	63,466
Operating lease liability, net of current portion	25,591	29,304
Other liabilities	474	1,721
Total long-term liabilities	67,546	94,491
Total liabilities	<u>\$ 188,586</u>	<u>\$ 212,644</u>
Series A preferred shares, no par value; 3,901,348 shares issued and outstanding at December 31, 2020 and 2019	<u>\$ 7,874</u>	<u>\$ 7,874</u>
Shareholders' equity:		
Ordinary shares, no par value; 48,778,678 and 34,340,690 shares issued and outstanding at December 31, 2020 and 2019, respectively	694,085	539,547
Additional paid-in capital	71,573	57,277
Accumulated other comprehensive income	389	267
Accumulated deficit	(683,269)	(533,359)
Total shareholders' equity	<u>82,778</u>	<u>63,732</u>
Total liabilities, Series A preferred shares and shareholders' equity	<u>\$ 279,238</u>	<u>\$ 284,250</u>

WAVE LIFE SCIENCES LTD.
UNAUDITED CONSOLIDATED STATEMENTS OF OPERATIONS AND COMPREHENSIVE LOSS
(In thousands, except share and per share amounts)

	<u>Three Months Ended December 31,</u>		<u>Twelve Months Ended December 31,</u>	
	<u>2020</u>	<u>2019</u>	<u>2020</u>	<u>2019</u>
Revenue	\$ 9,439	\$ 2,400	\$ 20,077	\$ 15,983
Operating expenses:				
Research and development	30,033	49,128	130,944	175,431
General and administrative	9,719	13,805	42,510	48,869
Total operating expenses	<u>39,752</u>	<u>62,933</u>	<u>173,454</u>	<u>224,300</u>
Loss from operations	(30,313)	(60,533)	(153,377)	(208,317)
Other income, net:				
Dividend income	24	736	584	4,912
Interest income (expense), net	—	4	(16)	29
Other income, net	659	3,023	2,058	9,738
Total other income, net	<u>683</u>	<u>3,763</u>	<u>2,626</u>	<u>14,679</u>
Loss before income taxes	(29,630)	(56,770)	(150,751)	(193,638)
Income tax benefit (provision), net	841	—	841	—
Net loss	<u>\$ (28,789)</u>	<u>\$ (56,770)</u>	<u>\$ (149,910)</u>	<u>\$ (193,638)</u>
Net loss per share attributable to ordinary shareholders—basic and diluted	<u>\$ (0.59)</u>	<u>\$ (1.65)</u>	<u>\$ (3.82)</u>	<u>\$ (5.72)</u>
Weighted-average ordinary shares used in computing net loss per share attributable to ordinary shareholders—basic and diluted	<u>48,777,001</u>	<u>34,303,975</u>	<u>39,227,618</u>	<u>33,866,487</u>
Other comprehensive income (loss):				
Net loss	\$ (28,789)	\$ (56,770)	\$ (149,910)	\$ (193,638)
Foreign currency translation	88	(15)	122	114
Comprehensive loss	<u>\$ (28,701)</u>	<u>\$ (56,785)</u>	<u>\$ (149,788)</u>	<u>\$ (193,524)</u>

Investor Contact:

Kate Rausch
617-949-4827
krausch@wavelifesci.com

Media Contact:

Alicia Suter
617-949-4817
asuter@wavelifesci.com



Wave Life Sciences
Corporate Presentation
March 4, 2021



Forward-looking statements

This document contains forward-looking statements. All statements other than statements of historical facts contained in this document, including statements regarding possible or assumed future results of operations, preclinical and clinical studies, business strategies, research and development plans, collaborations and partnerships, regulatory activities and timing thereof, competitive position, potential growth opportunities, use of proceeds and the effects of competition are forward-looking statements. These statements involve known and unknown risks, uncertainties and other important factors that may cause the actual results, performance or achievements of Wave Life Sciences Ltd. (the "Company") to be materially different from any future results, performance or achievements expressed or implied by the forward-looking statements. In some cases, you can identify forward-looking statements by terms such as "may," "will," "should," "expect," "plan," "aim," "anticipate," "could," "intend," "target," "project," "contemplate," "believe," "estimate," "predict," "potential" or "continue" or the negative of these terms or other similar expressions. The forward-looking statements in this presentation are only predictions. The Company has based these forward-looking statements largely on its current expectations and projections about future events and financial trends that it believes may affect the Company's business, financial condition and results of operations. These forward-looking statements speak only as of the date of this presentation and are subject to a number of risks, uncertainties and assumptions, including those listed under Risk Factors in the Company's Form 10-K and other filings with the SEC, some of which cannot be predicted or quantified and some of which are beyond the Company's control. The events and circumstances reflected in the Company's forward-looking statements may not be achieved or occur, and actual results could differ materially from those projected in the forward-looking statements. Moreover, the Company operates in a dynamic industry and economy. New risk factors and uncertainties may emerge from time to time, and it is not possible for management to predict all risk factors and uncertainties that the Company may face. Except as required by applicable law, the Company does not plan to publicly update or revise any forward-looking statements contained herein, whether as a result of any new information, future events, changed circumstances or otherwise.

Building a leading genetic medicines company



INNOVATIVE PLATFORM

- Stereopure oligonucleotides
- Novel backbone modifications (PN chemistry)
- Allele-selectivity
- Multiple modalities (silencing, splicing, ADAR editing)
- Strong IP position¹



FOUNDATION OF NEUROLOGY PROGRAMS

- Huntington's disease
- ALS / FTD
- Neuromuscular diseases
- Ataxias
- Parkinson's disease
- Alzheimer's disease



Wave's discovery and drug development platform



CLINICAL DEVELOPMENT EXPERTISE

- Multiple global clinical trials ongoing across eight countries
- Innovative trial designs



MANUFACTURING

- Established internal manufacturing capabilities to produce oligonucleotides at scale

WAVE[™]
LIFE SCIENCES

ALS: Amyotrophic lateral sclerosis; FTD: Frontotemporal dementia
¹stereopure oligonucleotides and novel backbone chemistry modifications

PRISM has unlocked novel and proprietary advances in oligonucleotide design

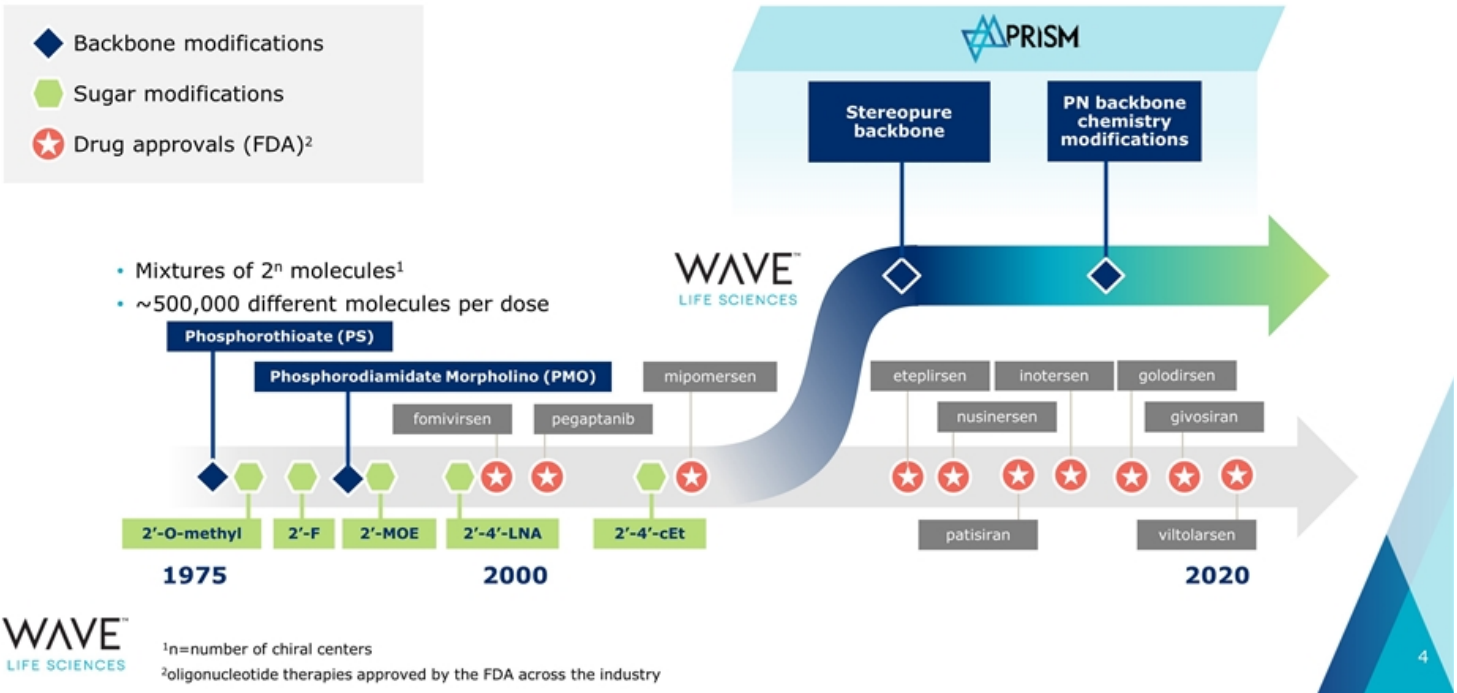

Innovative pipeline led by neurology programs

Therapeutic Area / Target	PRISM	Discovery	Preclinical	Clinical	Partner
NEUROLOGY					
Huntington's disease mHTT SNP1	◆	WVE-120101			Takeda 50:50 option
Huntington's disease mHTT SNP2	◆	WVE-120102			
Huntington's disease mHTT SNP3	◆ ◆	WVE-003			
ALS and FTD C9orf72	◆ ◆	WVE-004			
SCA3 ATXN3	◆ ◆				Takeda milestones & royalties
CNS diseases Multiple†	◆ ◆				
DMD Exon 53	◆ ◆	WVE-N531			
ADAR editing Multiple	◆ ◆				100% global
HEPATIC					
AATD (ADAR editing) SERPINA1	◆ ◆				100% global
OPHTHALMOLOGY					
Retinal diseases USH2A and RhoP23H	◆ ◆				100% global

WAVE™
LIFE SCIENCES

PRISM ◆ Stereopure ◆ PN chemistry

†During a four-year term, Wave and Takeda may collaborate on up to six preclinical targets at any one time.
ALS: Amyotrophic lateral sclerosis; FTD: Frontotemporal dementia; SCA3: Spinocerebellar ataxia 3; CNS: Central nervous system;
DMD: Duchenne muscular dystrophy; AATD: Alpha-1 antitrypsin deficiency



Platform evolution reflected in three upcoming clinical trials to start in 2021



- ✓ **Oligonucleotide optimization**
 - Stereopure backbone
 - PN backbone chemistry modifications
- ✓ ***In vivo* disease models**
 - Insight into PK / PD relationships
 - Novel model generation
- ✓ **Leverage learnings of first generation programs**
 - Translational pharmacology
 - Clinical trial design

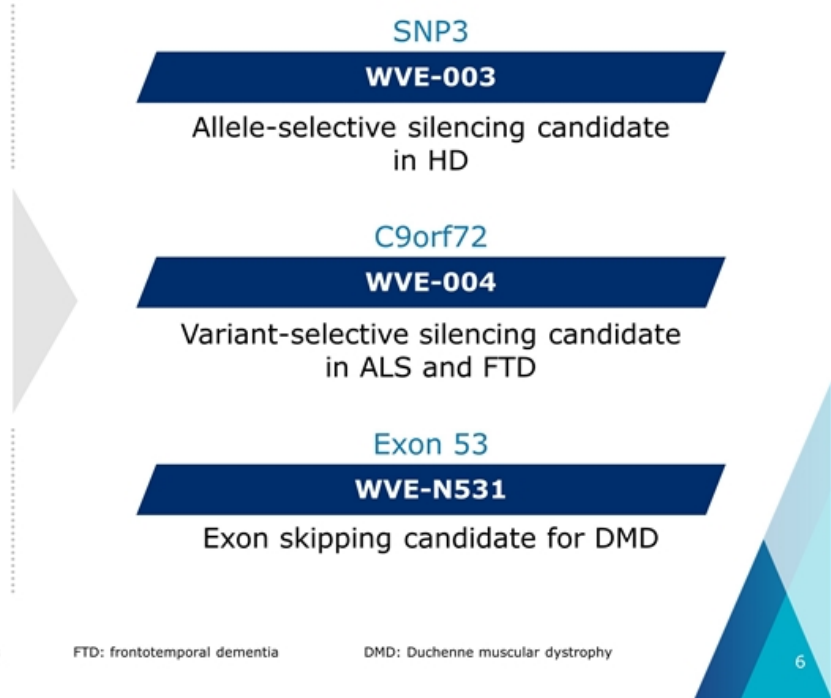

HD: Huntington's disease

ALS: amyotrophic lateral sclerosis

FTD: frontotemporal dementia

DMD: Duchenne muscular dystrophy

The logo for WAVE Life Sciences, featuring the word "WAVE" in a large, white, sans-serif font with a trademark symbol, and "LIFE SCIENCES" in a smaller, white, sans-serif font below it. The background is a dark blue triangle pointing downwards, set against a larger light blue triangle pointing upwards, creating a central white triangular space.

WAVE™
LIFE SCIENCES

WVE-120101
WVE-120102
WVE-003

Huntington's Disease Portfolio

Huntington's disease: a hereditary, fatal disorder

- Autosomal dominant disease, characterized by cognitive decline, psychiatric illness and chorea; fatal
- No approved disease-modifying therapies
- Expanded CAG triplet repeat in HTT gene results in production of mutant huntingtin protein (mHTT); accumulation of mHTT causes progressive loss of neurons in the brain
- Wild-type (healthy) HTT protein critical for neuronal function; evidence suggests wild-type HTT loss of function plays a role in Huntington's disease (HD)
- 30,000 people with HD in the US and more than 200,000 at risk of developing HD

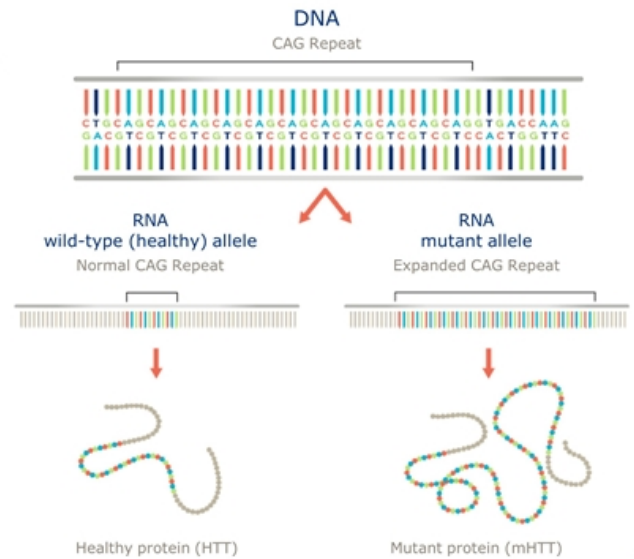

mHTT toxic effects lead to neurodegeneration, loss of wtHTT functions may also contribute to HD

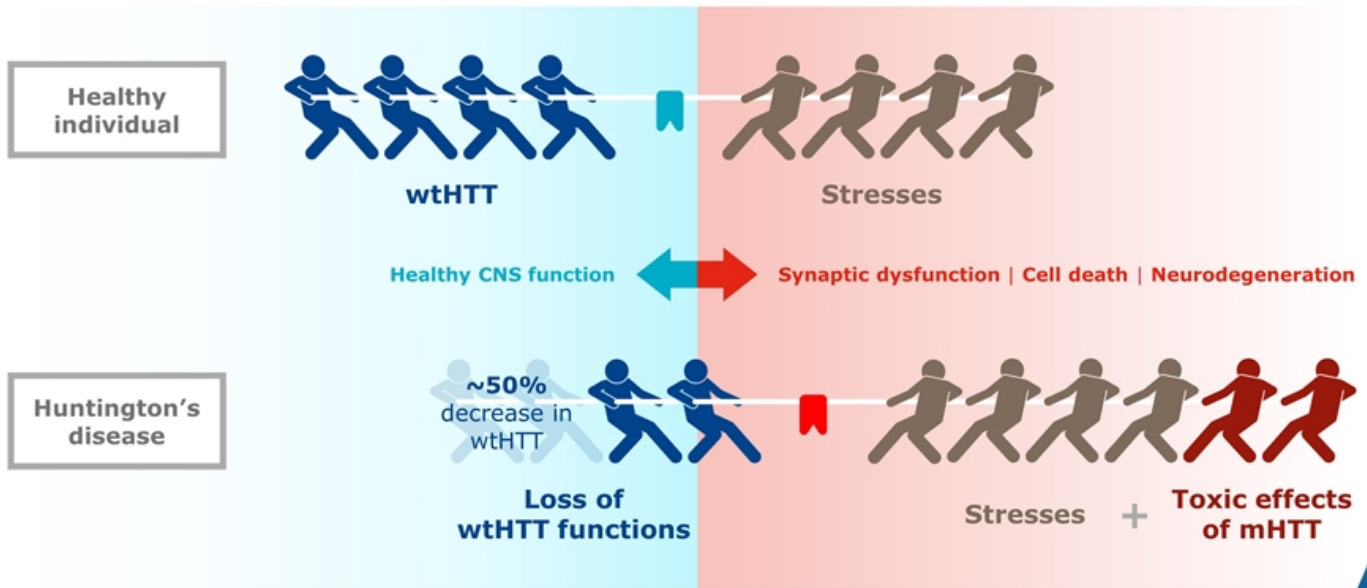

HD: Wild-type HTT is a critical protein for important functions in the central nervous system

NEURON



Promotes neuronal survival by protecting against stress (e.g., excitotoxicity, oxidative stress, toxic mHTT aggregates)¹⁻⁸

SYNAPSE



Plays an essential role in the transport of synaptic proteins—including neurotransmitters and receptors—to their correct location at synapses⁹⁻¹²

BRAIN CIRCUITS



Supplies BDNF to the striatum to ensure neuronal survival¹³⁻¹⁶
Regulates synaptic plasticity, which underlies learning and memory¹⁷⁻²²

CSF CIRCULATION



Plays a critical role in formation and function of cilia—sensory organelles that control the flow of CSF—which are needed to clear catabolites and maintain homeostasis²³

Nature publication contributes to weight of evidence on importance of wild-type huntingtin

nature

Article

Injured adult neurons regress to an embryonic transcriptional growth state

<https://doi.org/10.1038/s41586-020-2200-5>

Received: 12 April 2019

Accepted: 13 February 2020

Published online: 15 April 2020

[Check for updates](#)

Gunter H. D. Poplawski^{1,2}, Riki Kawaguchi^{1,2}, Erno Van Niekirk¹, Paul Li^{1,2}, Neil Mahata¹, Philip Canine¹, Richard Liu¹, Ioannis Dragatsis¹, Jessica M. Meiser¹, Binhai Zhang¹, Giovanni Coppola^{1,2} & Mark H. Tuszynski^{1,2}

Grafts of spinal-cord-derived neural progenitor cells (NPCs) enable the robust regeneration of corticospinal axons and restore forelimb function after spinal cord injury¹; however, the molecular mechanisms that underlie this regeneration are unknown. Here we perform translational profiling specifically of corticospinal tract (CST) motor neurons in mice, to identify their regenerative transcriptome after spinal cord injury and NPC grafting. Notably, both injury alone and injury combined with NPC grafts elicit virtually identical early transcriptional responses in host CST neurons. However, in mice with injury alone this regenerative transcriptome is downregulated after two weeks, whereas in NPC-grafted mice this transcriptome is sustained. The regenerative transcriptome represents a reversion to an embryonic transcriptional state of the CST neurons. The huntingtin gene (*Htt*) is a central hub in the regenerative transcriptome; deletion of *Htt* significantly attenuates regeneration, which shows that *Htt* has a key role in neural plasticity after injury.

- Conditional knock-out of *Htt* in 4-month old mice (post-neuronal development)
- Results suggest that:
 - 1) *Htt* plays a central role in the regenerating transcriptome (potentially influencing genes such as NFKB, STAT3, BDNF)
 - 2) *Htt* is essential for regeneration

“Indeed, conditional gene deletion showed that *Htt* is required for neuronal repair. Throughout life, neuronal maintenance and repair are essential to support adequate cellular functioning”

WAVE[™]
LIFE SCIENCES

Source: Poplawski et al., *Nature*, April 2019
Htt: Huntingtin protein

Wave approach: novel, allele-selective silencing

Aims to lower mHTT transcript while leaving healthy wild-type HTT relatively intact

- Utilize association between single nucleotide polymorphisms (SNPs) and genetic mutations to specifically target errors in genetic disorders, including Huntington's disease (HD)
- Potential to provide treatment for up to 80% of HD population

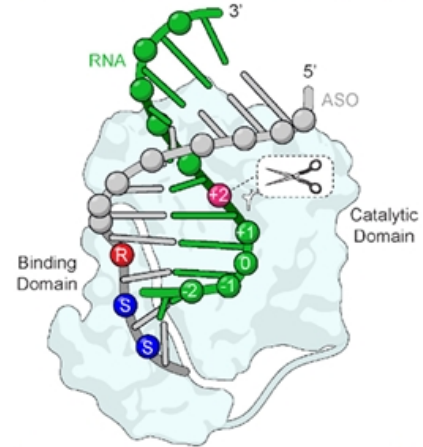

Allele-selectivity possible by targeting SNPs associated with expanded long CAG repeat in HTT gene

WVE-120101: Selective reduction of mHTT mRNA and protein

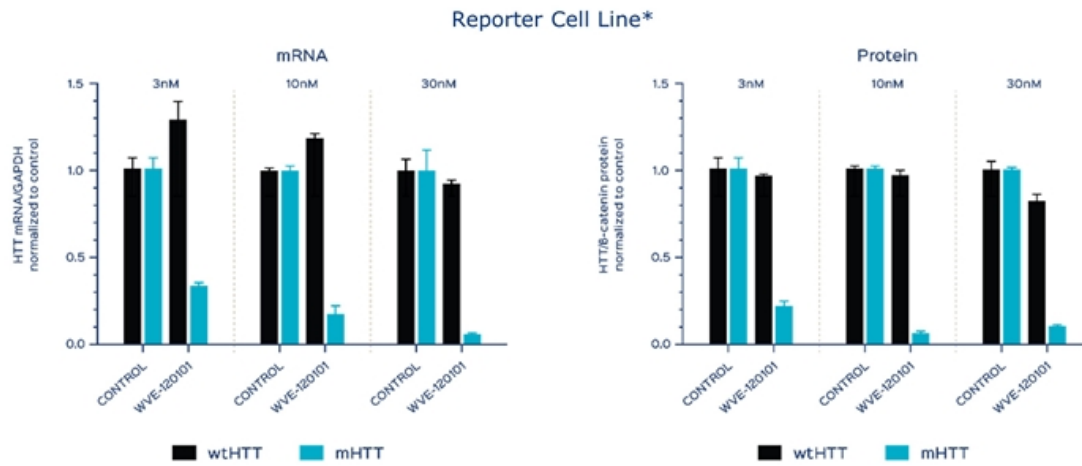

*These results were replicated in a patient-derived cell line

Demonstrated delivery to brain tissue

- WVE-120101 and WVE-120102 distribution in cynomolgus non-human primate brain following intrathecal bolus injection

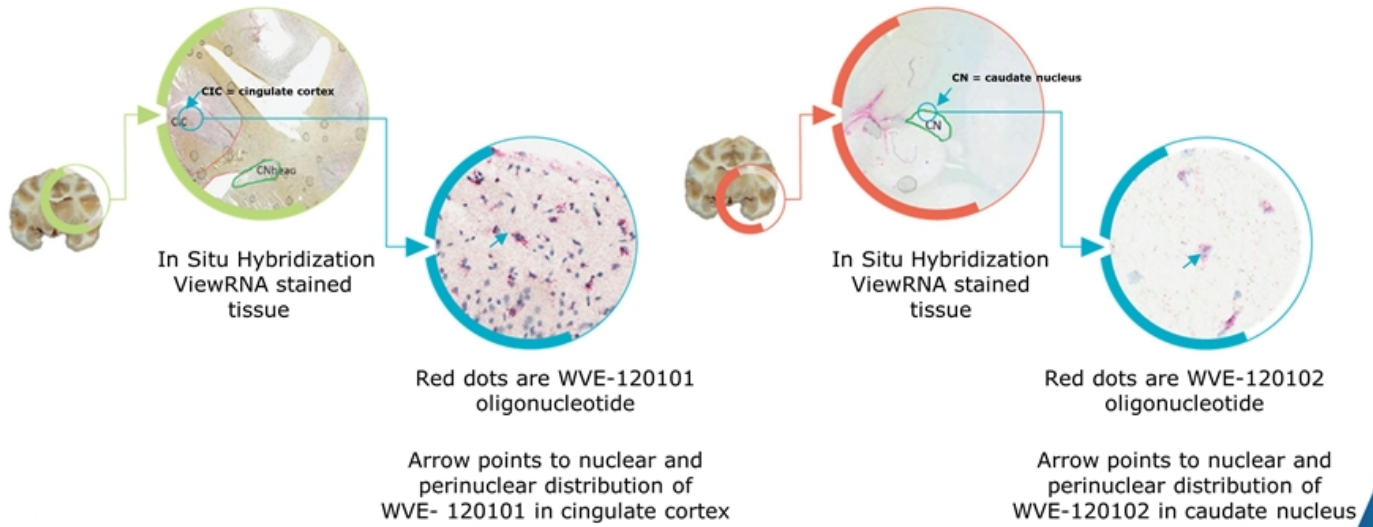

PRECISION-HD clinical trials

Two Phase 1b/2a clinical trials for WVE-120101 and WVE-120102

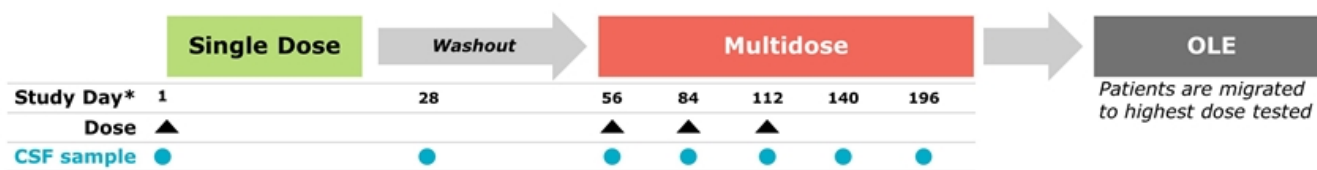

Trial results expected end of 1Q 2021

- **PRECISION-HD1 and OLE** (including complete 16 mg cohort)
- **PRECISION-HD2 and OLE** (including complete 32 mg cohort)

Results

- **Safety and tolerability**
- **Biomarkers**
 - mHTT
 - NfL
 - wtHTT





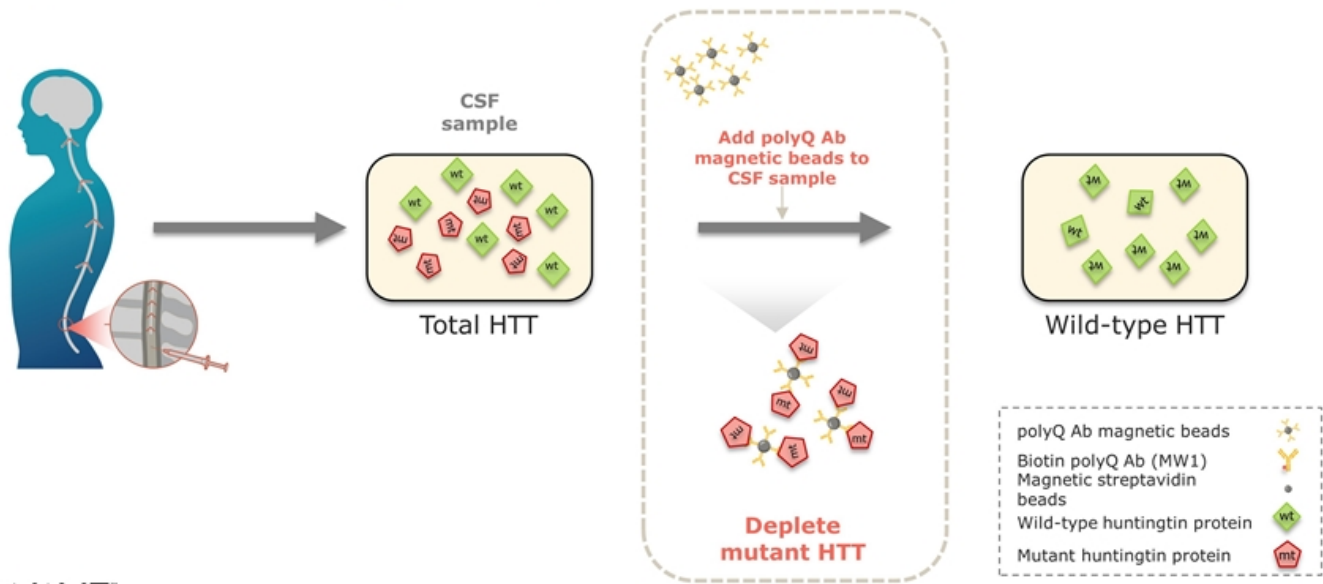

OLE: Open label extension; CSF: cerebrospinal fluid; mHTT: mutant huntingtin; NfL: neurofilament light chain; wtHTT: wild-type HTT
 *Study day may vary depending on patient washout period

Assessment of wild-type protein in CSF

Depletion of mutant HTT key to ability to measure wild-type HTT protein



polyQ Ab magnetic beads 
 Biotin polyQ Ab (MW1) 
 Magnetic streptavidin beads 
 Wild-type huntingtin protein 
 Mutant huntingtin protein 



Ab: antibody

CSF: cerebrospinal fluid

HTT: huntingtin protein MW1: Wild et al. JCI 2015

WVE-003 (SNP3) demonstrates selective, potent, and durable reduction of mHTT in preclinical models

Incorporates PN backbone chemistry modifications

Selectively reduces mHTT mRNA in HD iPSC neurons in vitro

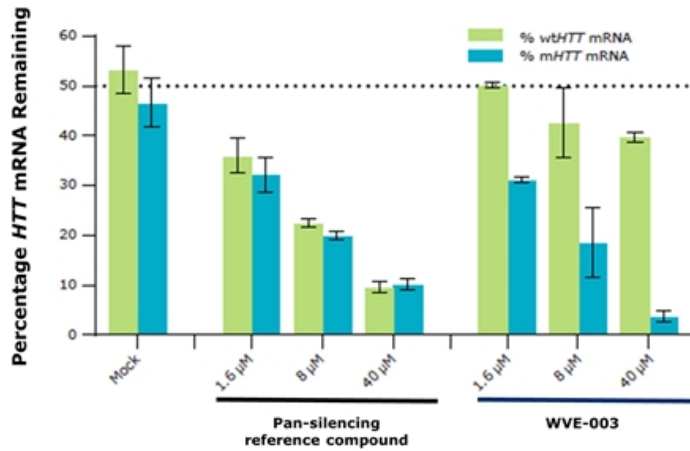

Durable striatal mHTT knockdown for 12 weeks in BACHD mouse model

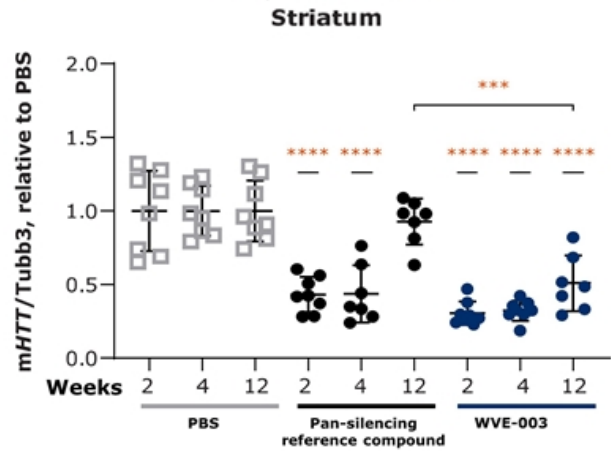

WAVE™
LIFE SCIENCES

Results from ND50036 iPSC-derived medium spiny neurons. Total *HTT* knockdown quantified by qPCR and normalized to *HPRT1* Oligonucleotide or PBS [100 μg ICV injections through a cannula on days 1, 3, and 5] delivered to BACHD transgenic. Mean ± SD (n=8, * $P < 0.0332$, *** $P < 0.0002$, **** $P < 0.0001$ versus PBS unless otherwise noted).
HPRT1, hypoxanthine-guanine phosphoribosyl transferase; iPSC, induced pluripotent stem cell; ICV, intracerebroventricular; PBS, phosphate-buffered saline

WVE-003: Clinical trial to leverage experience and learnings in HD

Leveraging learnings from PRECISION-HD

- Starting dose informed by preclinical *in vivo* models
- Asuragen assay to improve efficiency of patient identification
- Drawing from experience of sites from PRECISION-HD1 and PRECISION-HD2 trials

Adaptive SAD/MAD design

- Patients with confirmed manifest HD diagnosis with SNP3 mutation (up to 40 patients planned)
- Dose escalation and dosing interval guided by independent DSMB
- Safety and tolerability
- Biomarkers
 - mHTT
 - NfL
 - wtHTT
- Clinical trial site activation ongoing

Dosing in Phase 1b/2a trial expected to initiate in 2021

Three allele-selective HD programs

Potential to address ~80% of HD patient population

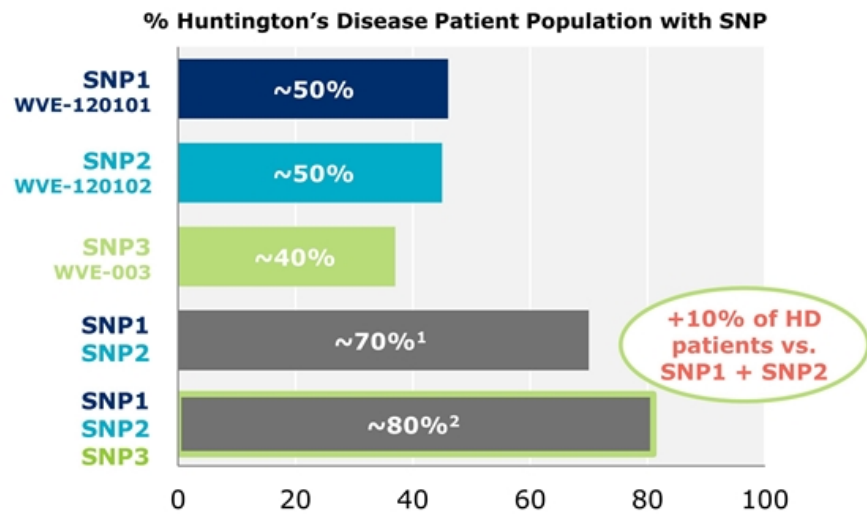

Intend to explore efficacy in early manifest and pre-manifest HD patient populations

¹ Percentage of patient population with SNP1 and/or SNP2

² Percentage of patient population with SNP1, SNP2 and/or SNP3

WVE-004

Amyotrophic Lateral Sclerosis (ALS)
Frontotemporal Dementia (FTD)

C9orf72 repeat expansions: A critical genetic driver of ALS and FTD

Normal (non-expanded) Allele

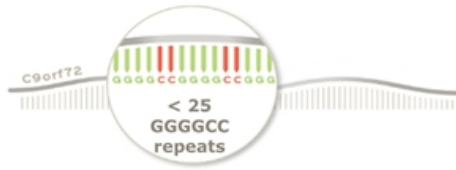

Expanded Allele



- C9orf72 hexanucleotide repeat expansions (GGGGCC) are one of the most common genetic causes of the sporadic and inherited forms of Amyotrophic Lateral Sclerosis (ALS) and Frontotemporal Dementia (FTD)
- The C9orf72 repeat expansions also lead to accumulation of repeat-containing transcripts, nuclear sequestration of RNA binding proteins and synthesis of toxic dipeptide-repeat (DPR) proteins
- The C9orf72 repeat expansions lead to reduced expression of wild-type C9orf72 and to cellular changes that reduce neuronal viability

C9-ALS and C9-FTD: Manifestations of a clinical spectrum

	Disease	C9 specific US population	Mean disease duration	Standard of care
C9-ALS	<ul style="list-style-type: none"> Fatal neurodegenerative disease Progressive degeneration of motor neurons in brain and spinal cord 	~2,000	3.1 years	Significant unmet need despite two approved therapies in US
C9-FTD	<ul style="list-style-type: none"> Progressive neuronal atrophy in frontal/temporal cortices Personality and behavioral changes, gradual impairment of language skills 	~10,000	6.4 years	No approved disease modifying therapies

Two devastating diseases with a shared genetic basis



ALS: Amyotrophic lateral sclerosis; FTD: Frontotemporal dementia
Sources: Cammack et al, Neurology, October 2019. Moore et al, Lancet Neurology, February 2020

C9orf72 repeat expansions: Mechanisms of cellular toxicity

- C9-ALS and C9-FTD may be caused by multiple factors:
 - Insufficient levels of C9orf72 protein
 - Accumulation of repeat-containing RNA transcripts
 - Accumulation of aberrantly translated DPR proteins
- Recent evidence suggests lowering C9orf72 protein exacerbates DPR-dependent toxicity

Variant-selective targeting could address multiple potential drivers of toxicity

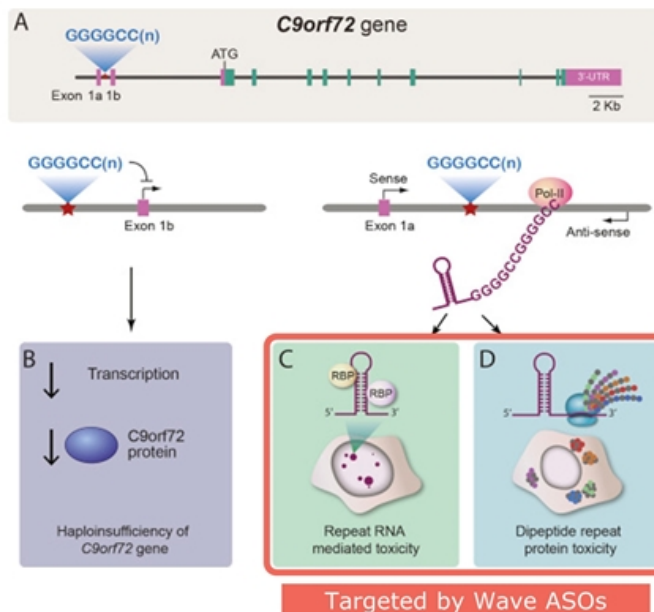

C9orf72 targeting strategy spares C9orf72 protein

- Normal C9orf72 allele produces three mRNA transcripts (~80% are V2, ~20% are V1 and V3)
- **Pathological allele** with expanded repeat leads to **healthy V2** and **pathological V1 and V3** transcript by-products

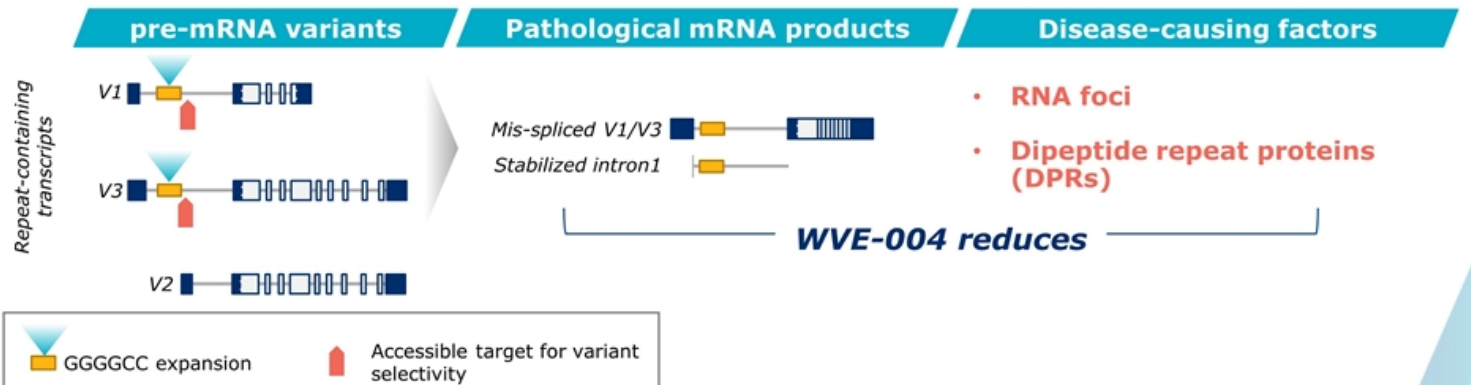

WVE-004 targets only V1 and V3 transcripts, sparing V2 transcripts and healthy C9orf72 protein

PN backbone chemistry modifications: Improved potency among C9orf72-targeting oligonucleotides *in vivo*

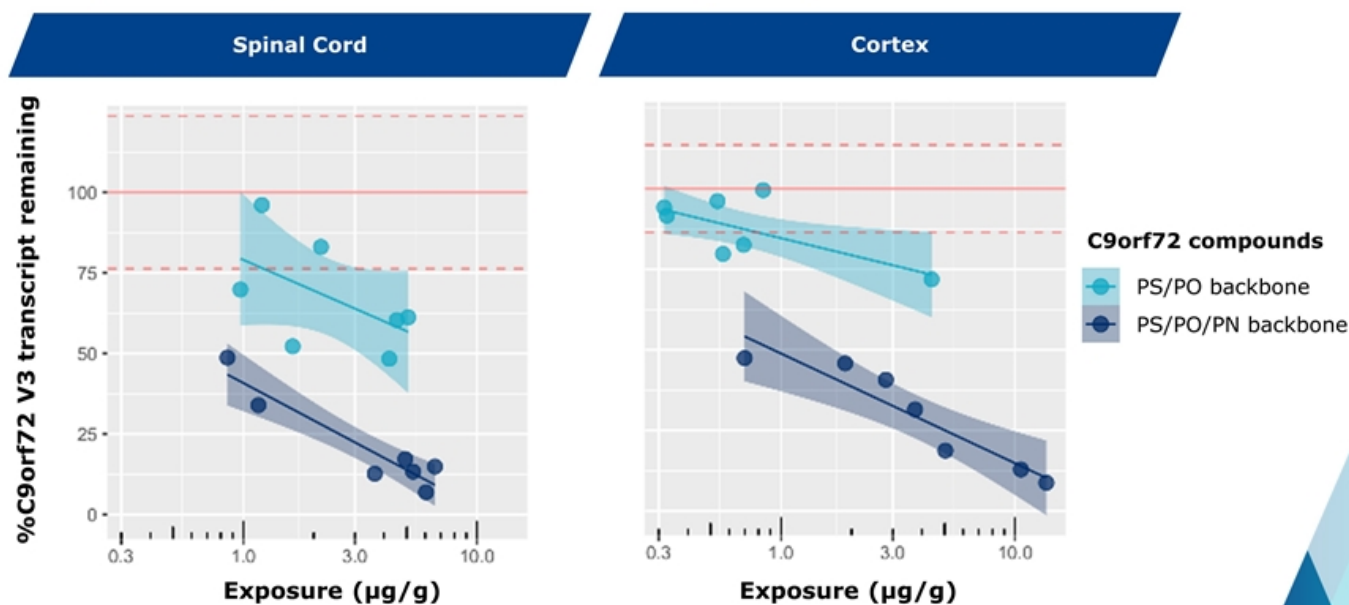

WVE-004: Potent and selective knockdown of repeat-containing transcripts *in vitro*

In vitro activity in C9 patient-derived neurons

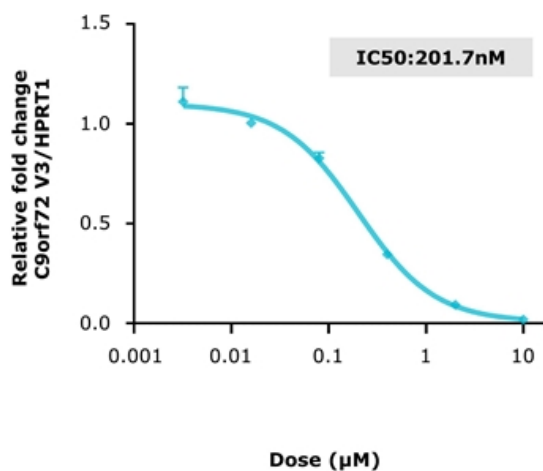

In vitro selectivity in C9 patient-derived neurons

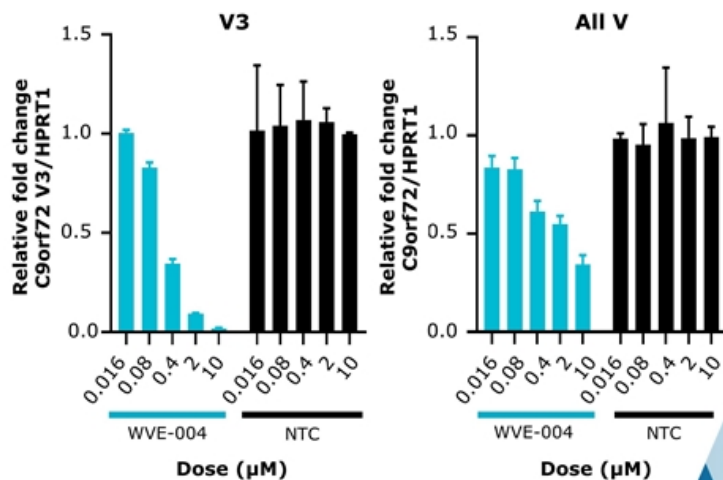

WVE-004 demonstrates durable reduction of DPRs in vivo after 6 months in spinal cord and cortex

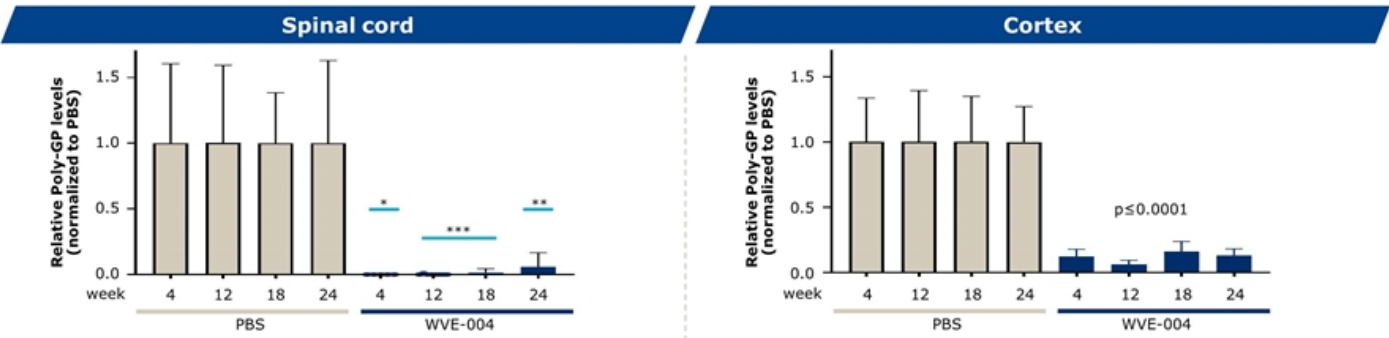

Healthy C9orf72 protein relatively unchanged ~6 months after WVE-004 administration

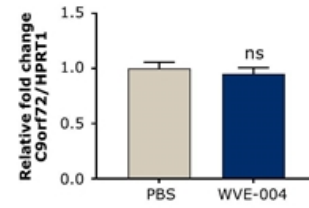
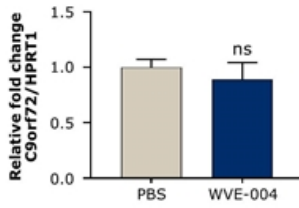

Full results presented at the 31st International Symposium on ALS/ MND (December 2020)
 Top: 2 x 50 ug (day 0, day 7) dosed ICV; DPRs measured by Poly-GPMSD assay. *: p ≤ 0.05 **: P ≤ 0.01, ***: P ≤ 0.001. ICV: Intracerebroventricular; DPR: Dipeptide repeat protein; Bottom: C9 BAC transgenic mice administered PBS or 50 ug WVE-004, ICV, (day 0, day 7). ns: not significant; PBS: phosphate-buffered saline



WVE-004: Adaptive SAD/MAD design to optimize dose level and frequency

- Patients with documented C9orf72 expansion and confirmed ALS, FTD, or mixed phenotype (up to 50 patients planned)
- Starting dose informed by preclinical *in vivo* models
- Dose escalation and dosing interval guided by independent DSMB
- Key biomarkers of target engagement and neurodegeneration will be assessed
 - PolyGP
 - NFL
- Key exploratory clinical outcome measures
 - ALSFRS-R and CDR-FTLD
- Clinical trial site activation ongoing

Dosing in Phase 1b/2a trial expected to initiate in 2021

WVE-N531
Duchenne muscular dystrophy

WVE-N531 *in vitro* dose-dependent dystrophin restoration

Dystrophin protein restoration of up to 71%

Western Blot normalized to primary healthy human myoblast lysate

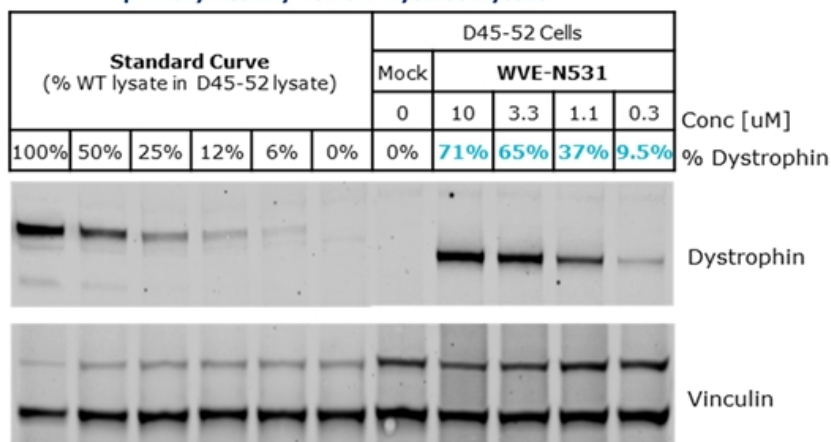

- WVE-N531 contains novel PN backbone chemistry modifications
- Free uptake for 6 days in differentiation media with no transfection agent and no peptide conjugated to the oligonucleotide
- Demonstrated a dose-dependent increase in dystrophin restoration in DMD patient-derived myoblasts



Experimental conditions: Δ45-52 (D45-52) patient myoblasts were treated with oligonucleotide for 6d under free-uptake conditions in differentiation media. Protein harvested in RIPA buffer and dystrophin restoration analyzed by Western Blot. Signal normalized to vinculin loading control and to primary healthy human myotube lysate (pooled from four donors) forming a standard curve in Δ45-52 cell lysate.

PN chemistry led to overall survival benefit in dKO model

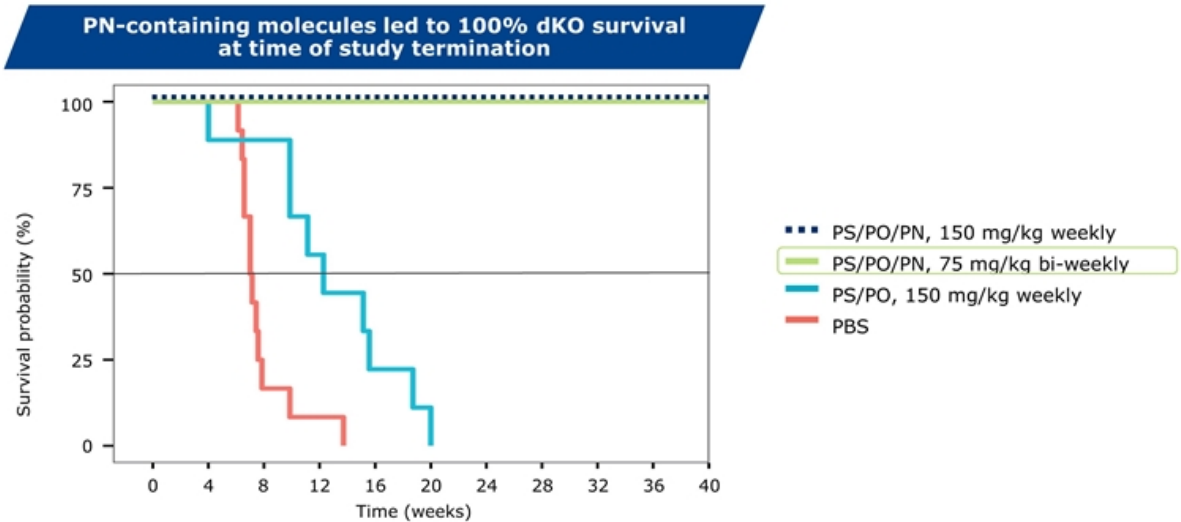

Note: Untreated, age-matched mdx mice had 100% survival at study termination [not shown]

Clinical trial of WVE-N531 to initiate in 2021

- Unmet need in DMD remains high
- Planned clinical trial designed to evaluate change in dystrophin production, drug concentration in muscle, and initial safety
 - Open-label study; targeting every-other-week administration in up to 15 boys with DMD
- Potential to apply PN chemistry to other exons if successful

CTA submission expected in 1Q 2021

WAVE[™]
LIFE SCIENCES



Wave's discovery and drug
development platform



Enables Wave to target genetically defined diseases with stereopure oligonucleotides across multiple therapeutic modalities

DESIGN

Unique ability to construct stereopure oligonucleotides with one defined and consistent profile

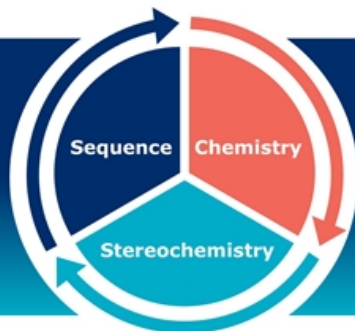

OPTIMIZE

A deep understanding of how the interplay among oligonucleotide sequence, chemistry, and backbone stereochemistry impacts key pharmacological properties

Through iterative analysis of *in vitro* and *in vivo* outcomes and machine learning-driven predictive modeling, Wave continues to define design principles that are deployed across programs to rapidly develop and manufacture clinical candidates that meet pre-defined product profiles



Multiple modalities
Silencing | Splicing | ADAR editing

PRISM platform enables rational drug design

Sequence

B: bases

A, T, C, mC, G, U,
other modified bases

Stereochemistry

Chiral control of
any stereocenter

5' modifications,
backbone modifications

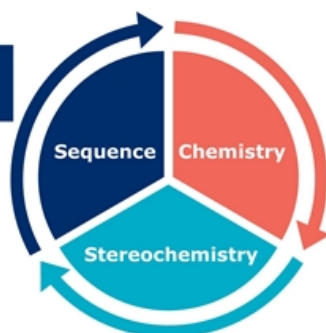

Chemistry

R: 2' modifications

OMe, MOE, F,
other modifications

X: backbone chemistry

Phosphodiester (PO),
phosphorothioate (PS),
Phosphoramidate diester
(PN)

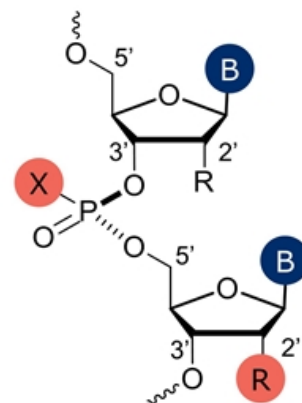

Expanding repertoire of backbone modifications with novel PN backbone chemistry



Backbone linkages

	PO	PS	PN
Backbone modification (X)	Phosphodiester 	Phosphorothioate 	Phosphoramidate diester
Stereochemistry	Not chiral	Chiral <ul style="list-style-type: none"> ◇ Stereorandom ▲ PS backbone Rp ▼ PS backbone Sp 	Chiral <ul style="list-style-type: none"> □ PN backbone Stereorandom ■ PN backbone Rp ▣ PN backbone Sp
Charge	Negative	Negative	Neutral
Depiction			
PRISM backbone modifications	PO/PS	PO/PS/PN	

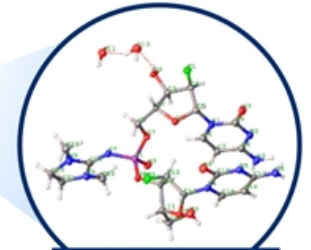

Phosphoryl guanidine x-ray structure

PN chemistry increases potency in silencing, splicing, and editing preclinical studies

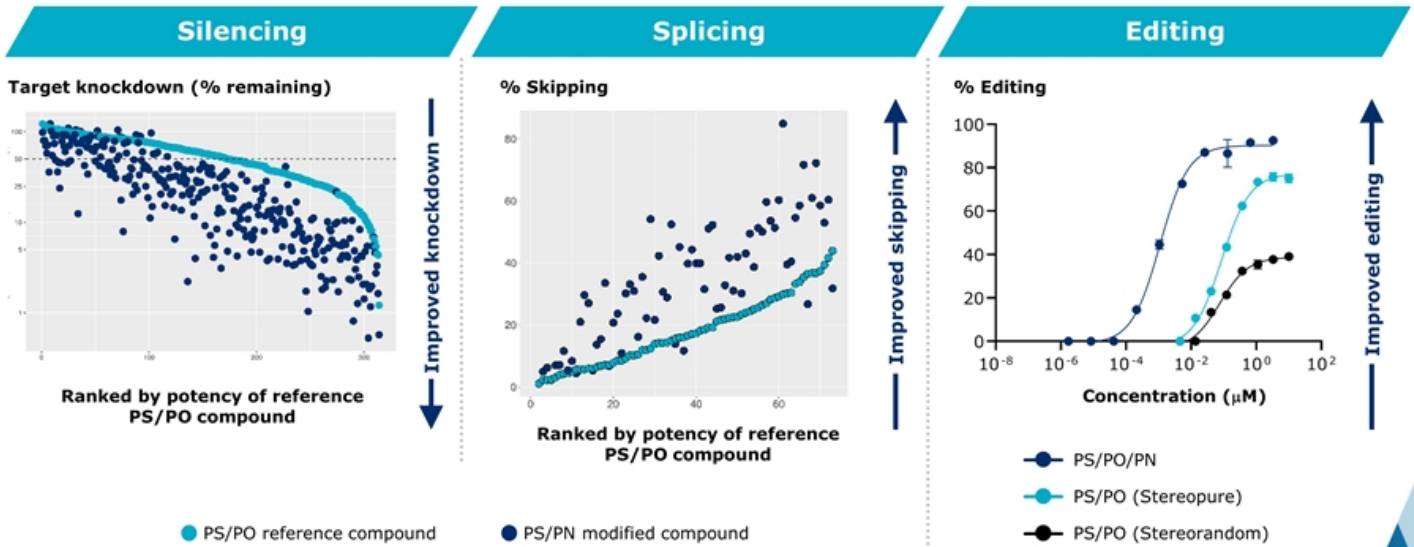

Lead program in Takeda collaboration reinforces potential of PN chemistry in the CNS



Substantial and widespread target mRNA reduction following single intrathecal dose in NHPs

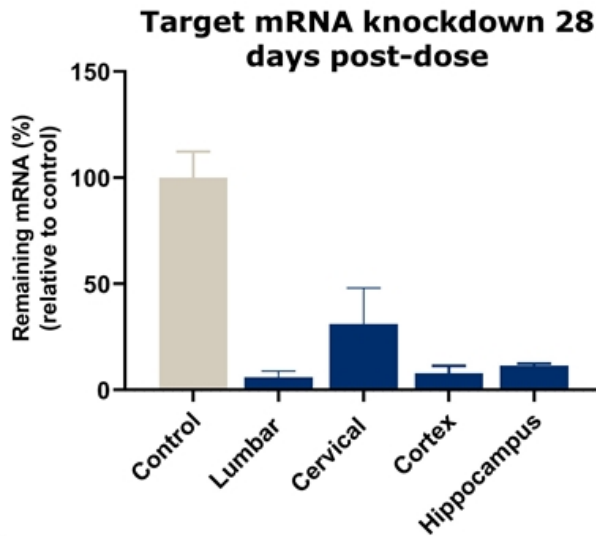

- Single IT dose of 12 mg (n=3)
- Therapeutic candidate widely distributed across brain and spinal cord
- ~90% mRNA knockdown one-month following single dose



NHPs: Non-human primates; IT: intrathecal
NHPs were administered 12 mg on day 1 via IT bolus injection; tissue samples were collected from 3 NHPs at 28 days post-dose.

PRISM enables optimal placement of backbone stereochemistry

Crystal structure confirms phosphate-binding pocket of RNase H binds 3'-SSR-5' motif in stereopure oligonucleotide – supports design strategy for Wave oligonucleotides

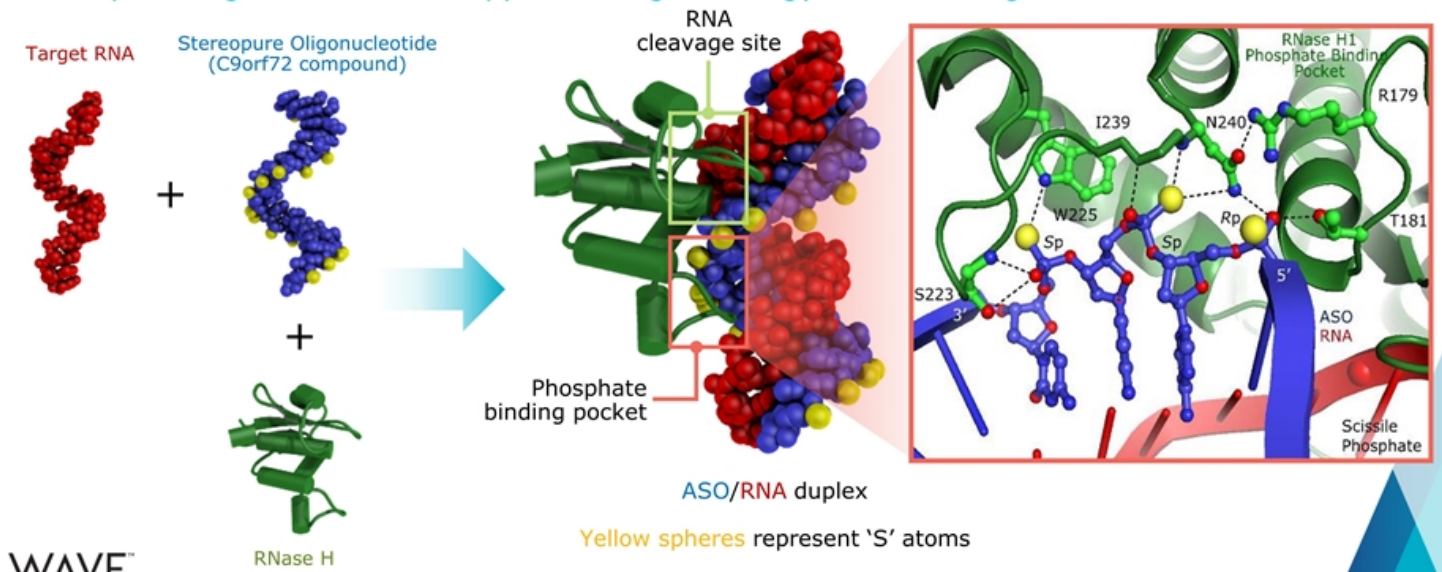

Importance of controlling stereochemistry

Stereochemical diversity

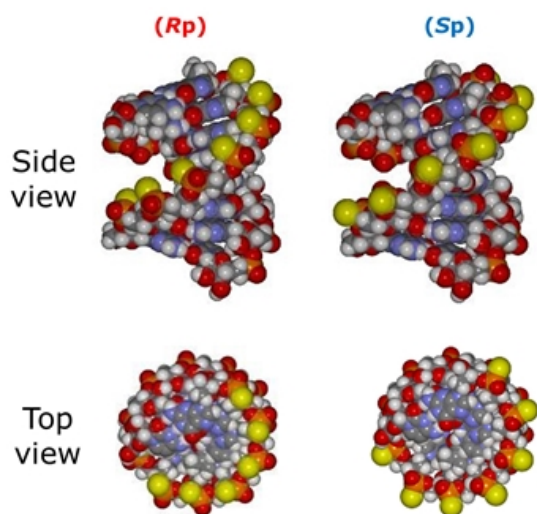

WAVE™

LIFE SCIENCES Yellow spheres represent 'S' atoms

PS: Phosphorothioate

Exponential diversity arises from uncontrolled stereochemistry

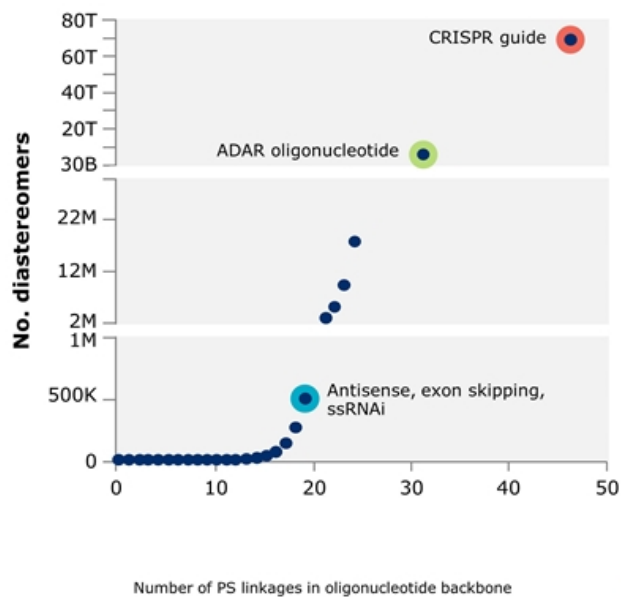

ADAR editing
Platform capability and
Alpha-1 antitrypsin deficiency

PRISM platform has unlocked ADAR editing

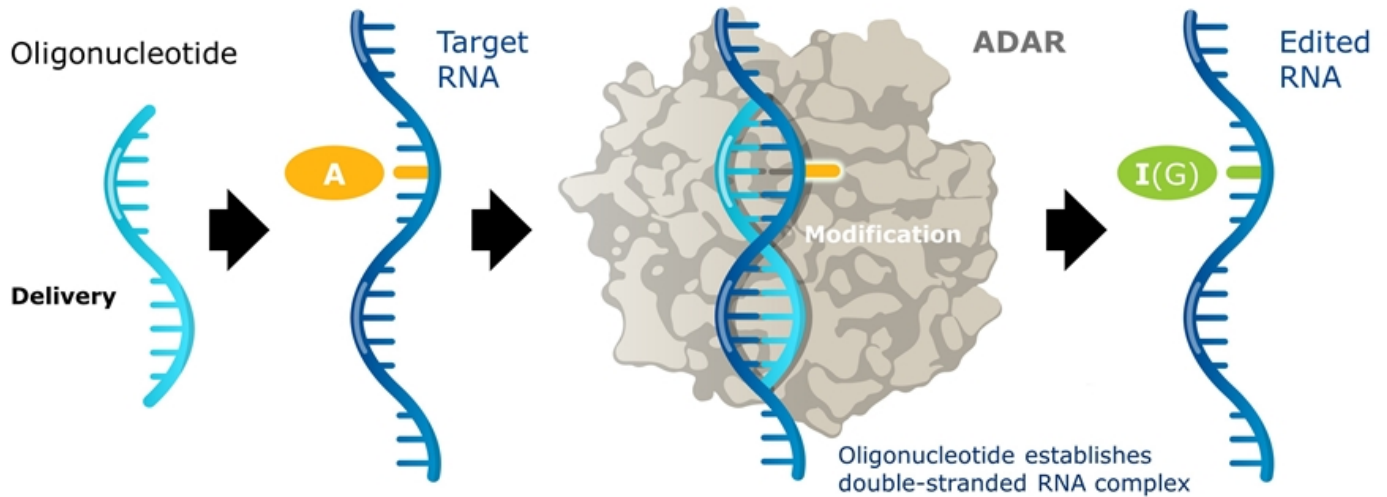

- **A-to-I** editing is one of most common post-transcriptional modifications
- ADAR is ubiquitously expressed across tissues, including liver and CNS

PRISM enables practical approach to RNA editing without need for viruses or exogenous protein

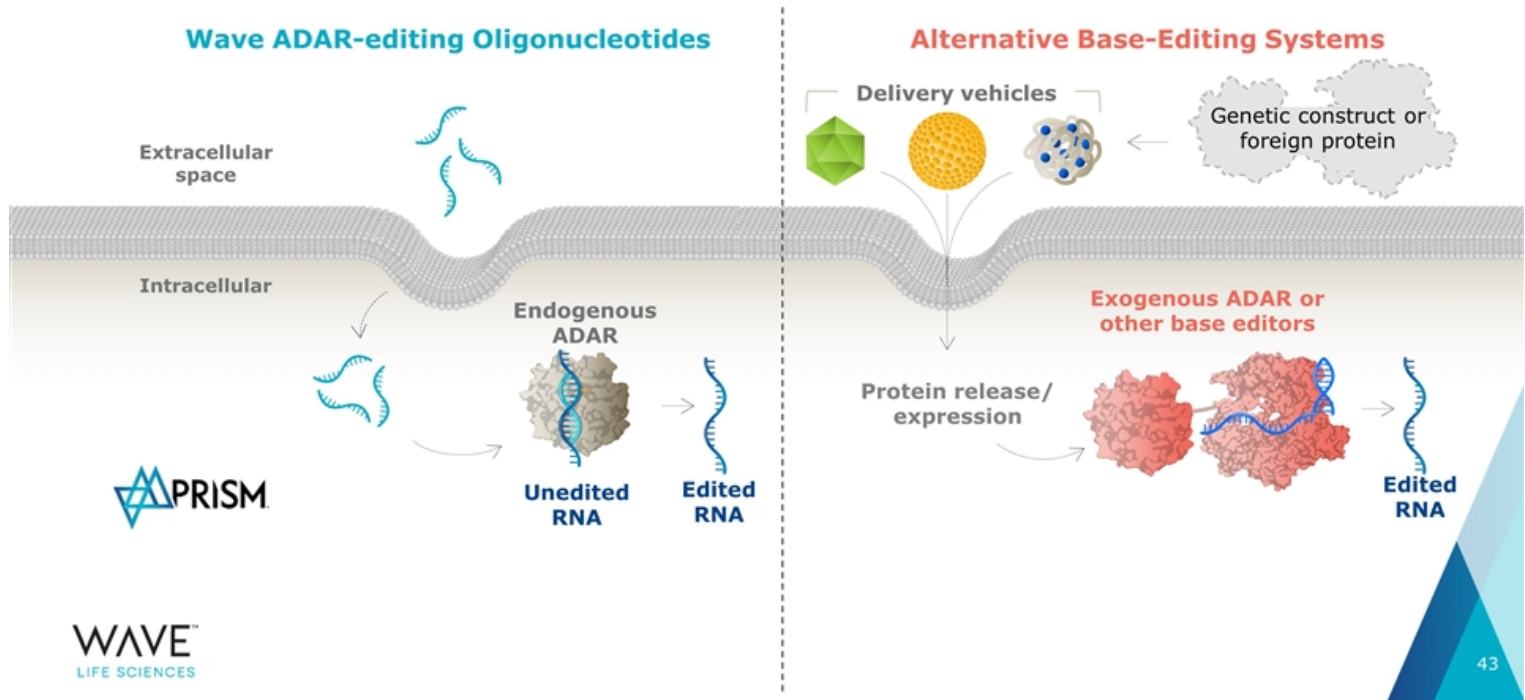

Advantages of Wave ADAR editing platform

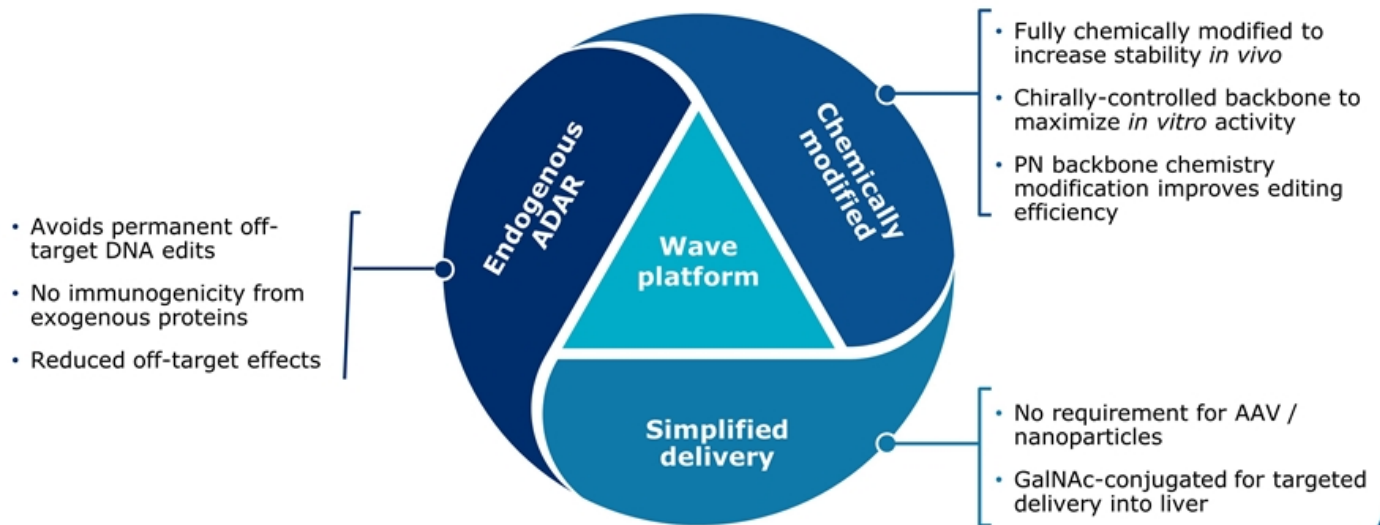

ADAR amenable diseases represent a sizeable opportunity

Potentially pathogenic human SNPs by base pair corrections

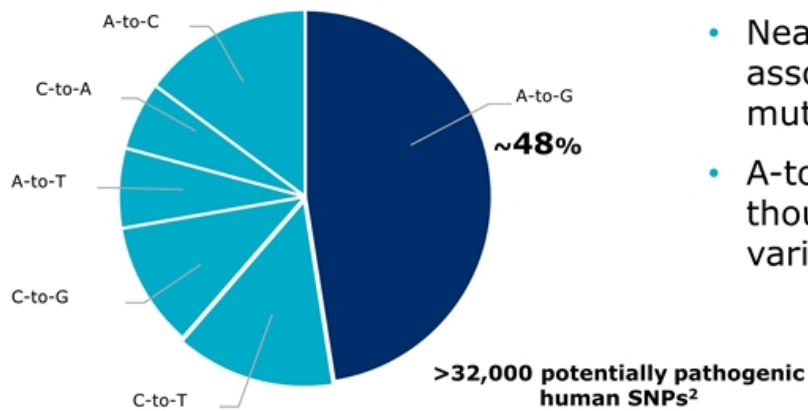

- Nearly half of known human SNPs associated with disease are G-to-A mutations
- A-to-I(G) editing could target tens of thousands of potential disease variants¹

RNA editing opens many new therapeutic applications

Restore protein function

- Fix nonsense and missense mutations that cannot be splice-corrected
- Remove stop mutations
- Prevent protein misfolding and aggregation

Examples:

Recessive or dominant genetically defined diseases

Modify protein function

- Alter protein processing (e.g. protease cleavage sites)
- Protein-protein interactions domains
- Modulate signaling pathways

Examples:

Ion channel permeability

Protein upregulation

- miRNA target site modification
- Modifying upstream ORFs
- Modification of ubiquitination sites

Examples:

Haploinsufficient diseases

Significant ADAR editing demonstrated *in vitro* in NHP and primary human hepatocytes

ACTB GalNAc-conjugated oligonucleotides with stereopure PN backbone chemistry modifications

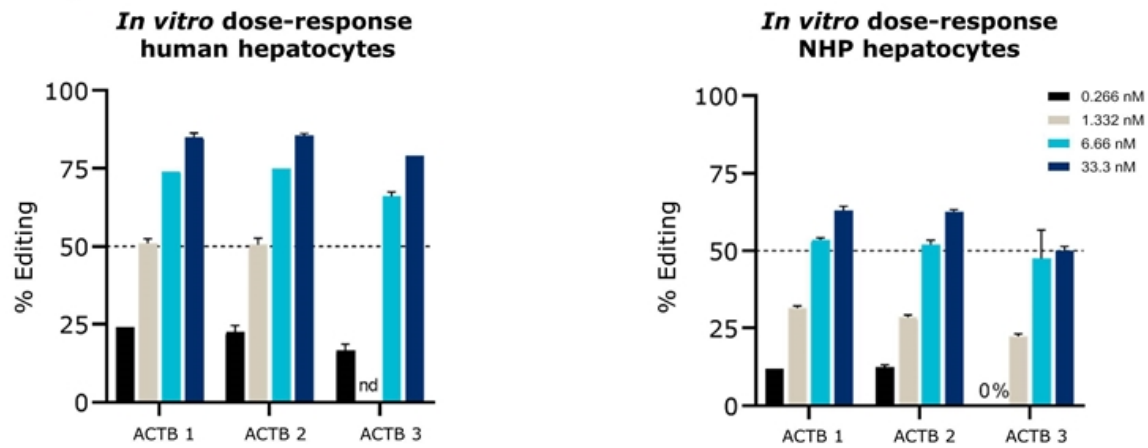

Efficient ADAR editing translated *in vivo* in non-human primate study

- Up to 50% editing efficiency observed at Day 7, 2 days post last dose
- Substantial and durable editing out to at least Day 50, 45 days post last dose

In vivo editing in NHP following subcutaneous administration

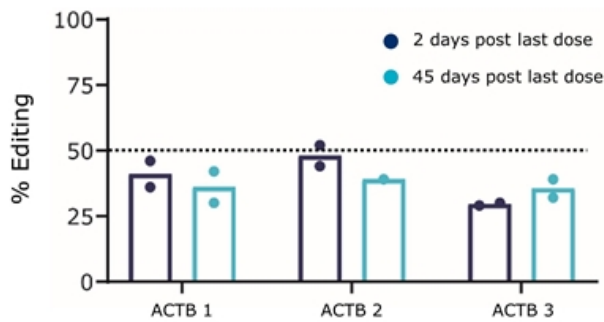

Oligonucleotide quantification in NHP following subcutaneous administration

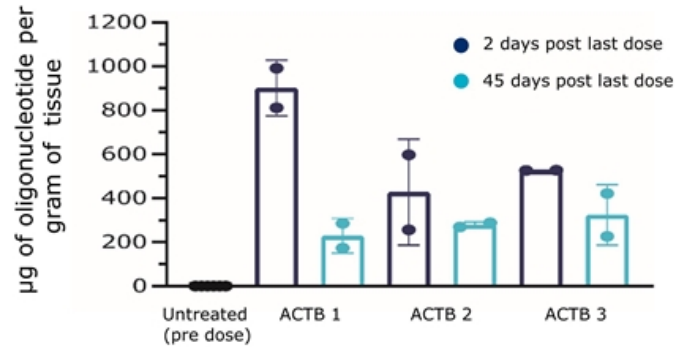

Wave ADAR editing oligonucleotides are highly specific

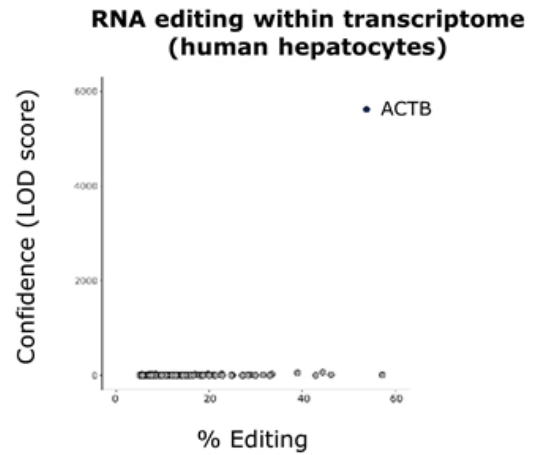
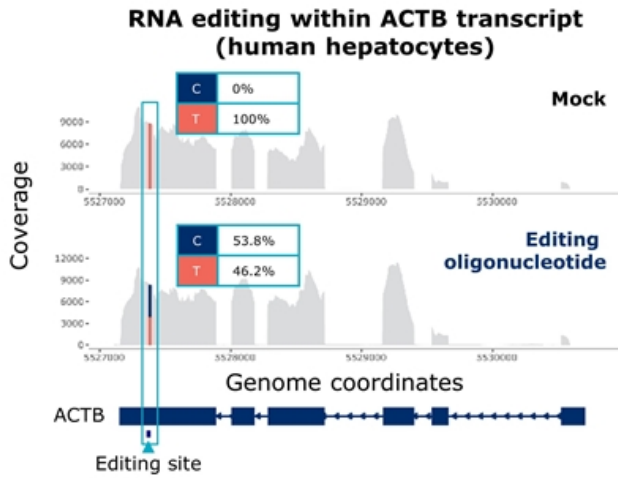

Advancing Wave's first ADAR editing program in alpha-1 antitrypsin deficiency (AATD)

- Most common cause is a single G-to-A point mutation on the "Z" allele
- **~200K people in US and EU** with homozygous ZZ genotype, most common form of severe AATD
- Approved therapies modestly increase circulating levels of wild-type AAT in those with lung pathology; no therapies address liver pathology

Wave's approach may simultaneously address lung and liver manifestations by using ADAR editing to correct mutation:

- Increase circulating levels of wild-type AAT protein
- Reduce aggregation of Z-AAT in liver
- Retain wild-type AAT physiological regulation

Dual pathologies in AATD

Loss of function in lung

Lack of functional AAT in serum:

- Insufficient levels to counteract protease levels, e.g., neutrophil elastase
- Lung damage due to unchecked proteolytic activity and inflammation
- Other tissues may be affected (e.g., skin)



Gain of function in liver

Misfolding of AAT in hepatocytes:

- Inability to secrete AAT
- AAT polymerizes in liver
- Liver damage/cirrhosis

SERPINA1 Z allele mRNA editing increases edited AAT protein concentration *in vitro*

In primary hepatocyte *SERPINA1* Z cell model, editing the Z allele mRNA back to wild-type prevents protein misfolding and increases secretion of edited AAT protein from hepatocytes

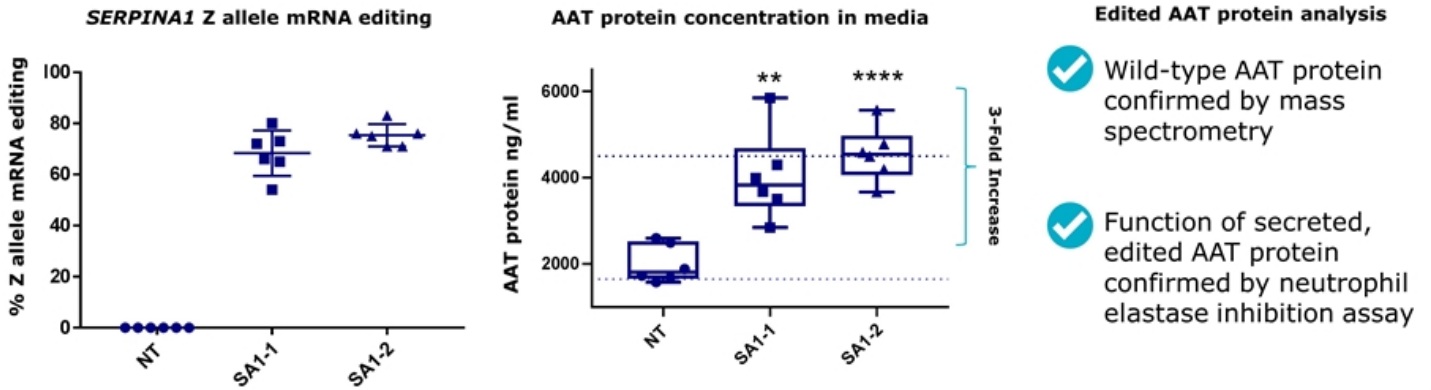

Model validation and *in vivo* data expected 1H 2021

WAVE[™]
LIFE SCIENCES

AAT (alpha-1 antitrypsin); Mouse primary hepatocytes that express *SERPINA1* Z allele mRNA were transfected with 25 nanomolar (nM) of *SERPINA1* (SA1-1 and SA1-2) targeting antisense oligonucleotides (ASOs) and a control non-targeting (NT) ASO. Media and RNA was collected at 5 days post transfection. AAT protein in media was quantified by Elisa Assay, RNA editing was quantified by RT/PCR/Sanger sequencing.

Proprietary humanized mouse model developed to support ADAR platform

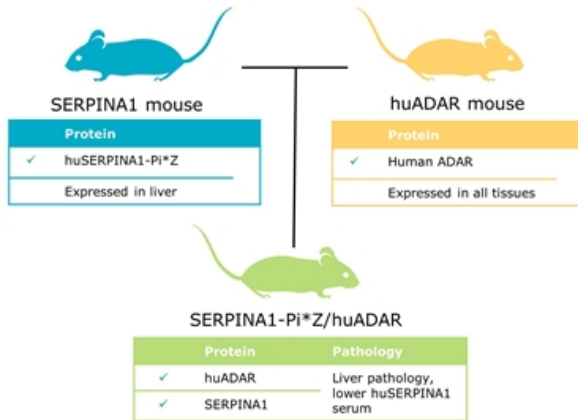

- Expression of huADAR in mouse is comparable to expression in human cells
- Expression of huADAR restores editing of endogenous targets in primary mouse cell types to levels seen in human primary cell types
- huADAR mouse model can be crossed with disease specific mouse models to provide model systems for use across Wave's ADAR editing programs

Model validation and *in vivo* data expected 1H 2021

Multiple opportunities for ADAR editing in neurology

ACTB editing in iCell Neurons

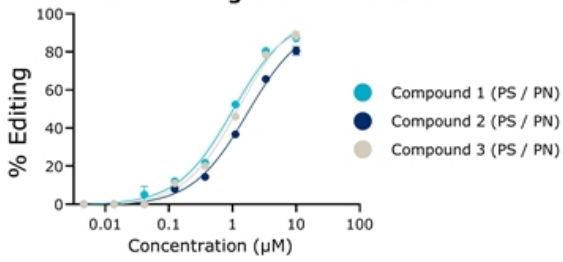

ACTB editing in human iCell Astrocytes

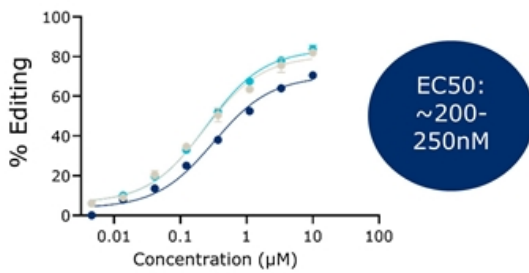

WAVE™
LIFE SCIENCES

Gymnotic uptake; Total RNA was harvested, reverse transcribed to generate cDNA, and the editing target site was amplified by PCR and quantified by Sanger sequencing

In vivo CNS editing in proprietary hADAR transgenic mouse (1 week)

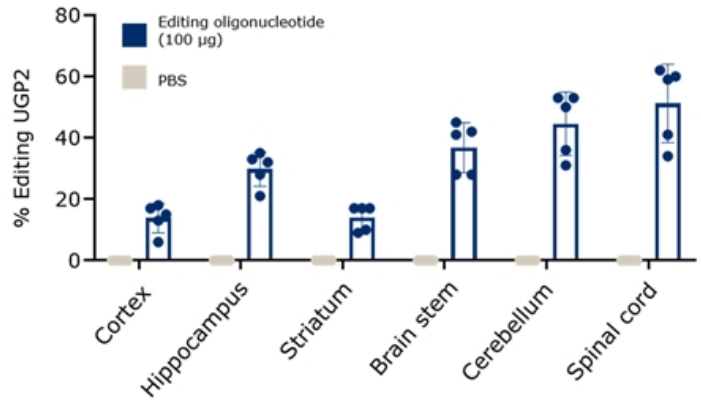

hADAR: human ADAR; UGP2: Glucose Pyrophosphorylase 2; 5 mice in each group were injected with PBS or a single 100µg dose on day 0. Animals were necropsied on day 7. RNA was harvested and editing measured by Sanger sequencing.

PRISM

Ophthalmology

Stereopure oligonucleotides for inherited retinal diseases (IRDs)

Wave ophthalmology opportunity

- Oligonucleotides can be administered by intravitreal injection; targeting twice per year dosing
- Stereopure oligonucleotides open novel strategies in both dominant and recessive IRDs; potential for potent and durable effect with low immune response

Successful targeting of *MALAT1* is a surrogate for an ASO mechanism of action

- Widely expressed in many different cell types
- Only expressed in the nucleus

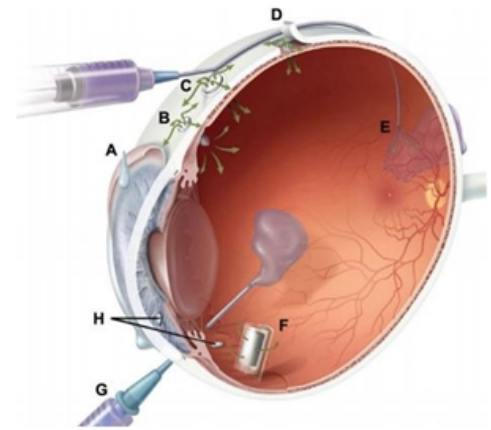

Intravitreal injection

Durable Malat1 knockdown through 9 months with PN backbone chemistry modifications

~50% Malat1 knockdown at 36 weeks in the posterior of the eye

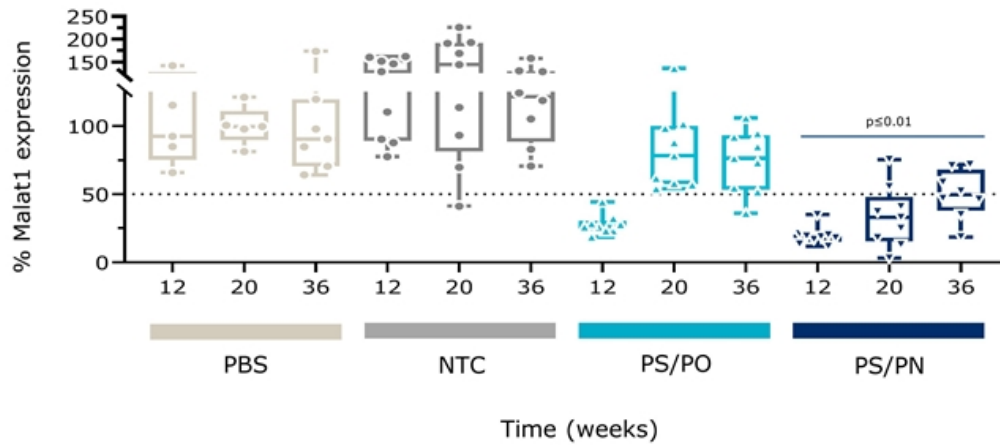

Usher Syndrome Type 2A: a progressive vision loss disorder

- Autosomal recessive disease characterized by hearing loss at birth and progressive vision loss beginning in adolescence or adulthood
- Caused by mutations in USH2A gene (72 exons) that disrupt production of usherin protein in retina, leading to degeneration of the photoreceptors
- No approved disease-modifying therapies
- **~5,000 addressable patients in US**

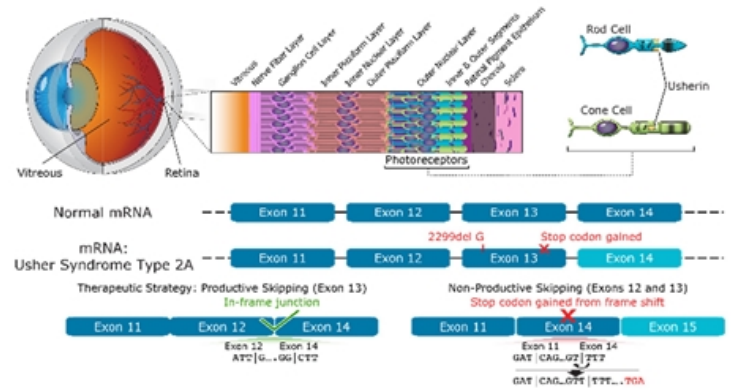

Oligonucleotides that promote USH2A exon 13 skipping may restore production of functional usherin protein

Potent USH2A exon 13 skipping with stereopure compound in *in vitro* and *ex vivo*

Enhanced potency over a stereorandom reference compound (*in vitro*)

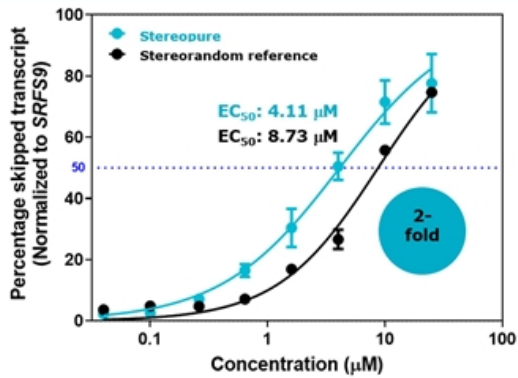

Target engagement in NHP retinas

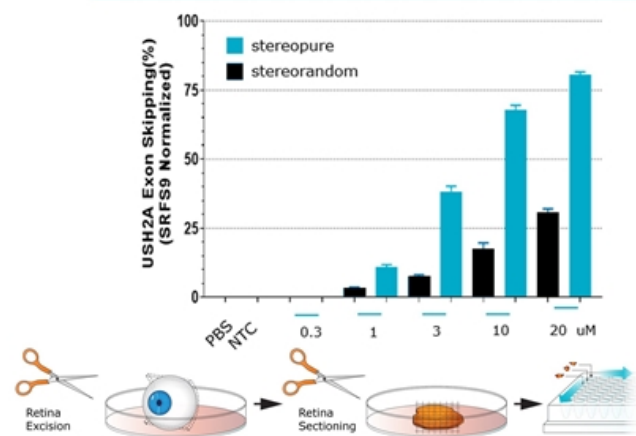

Stereopure oligonucleotide elicits dose-dependent exon skipping in NHP eye *in vivo*

Dose-dependent and specific exon skipping in NHP eye

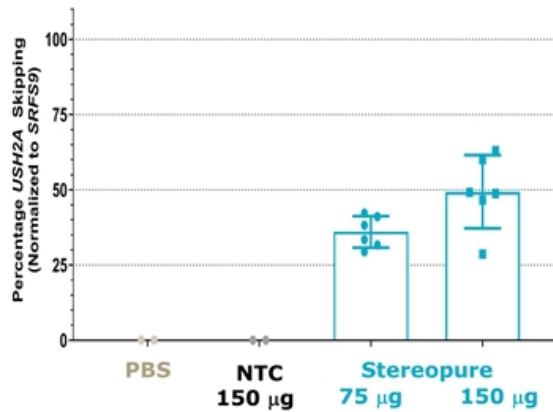

- Oligonucleotide is complementary to NHP *USH2A* exon 12*
- Evaluated 1-week post-single IVT injection
- Dose-dependent activity of **stereopure** oligonucleotides
- Substantial exposure in retina
- Exon-skipping integrity confirmed by RNA-seq at both doses

*NHP exon 12 = human exon 13

Allele-selective reduction of SNP-containing allele for adRP associated with Rhodopsin P23H mutation

- **Retinitis pigmentosa (RP)**: group of rare, genetic eye disorders resulting in progressive photoreceptor cell death and gradual functional loss; currently no cure
- ~10% of US autosomal dominant RP cases are caused by the P23H mutation in the rhodopsin gene (RHO)
- Mutant P23H rhodopsin protein is thought to misfold and co-aggregate with wild-type rhodopsin, resulting in a gain-of-function or dominant negative effect in rod photoreceptor cells

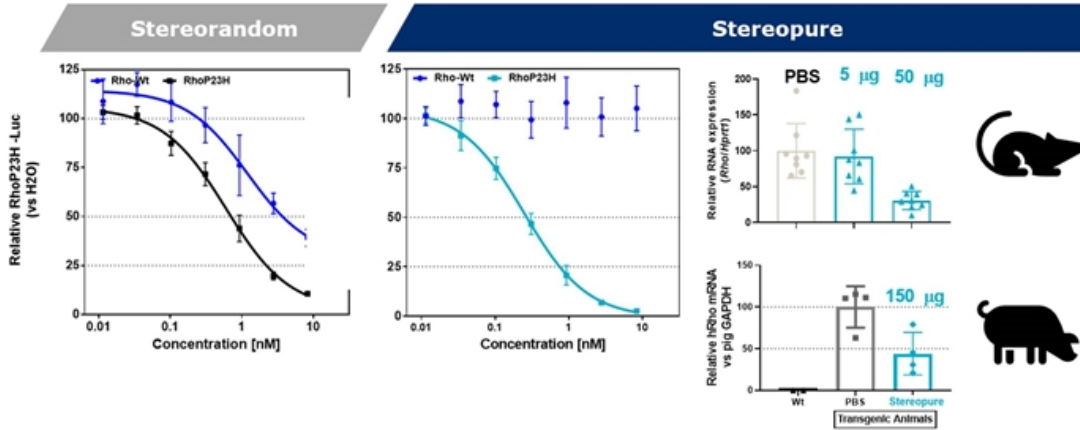

WAVE[™]
LIFE SCIENCES

Left: Reporter assays on a sequence described in WO2016138353A1. Oligonucleotide and luciferase reporter plasmids (wild-type and mutant RHO) are transfected into Cos7 cells. Cells are harvested after 48 hrs, and relative luminescence is measured. Right: Single IVT Injection (1 mL) in mouse Rho P23H mouse model or (150 mL) in human P23H pig model. Eyes collected 1-week post injection for mouse or 2-weeks post injection for pig; RNA isolated; Rho, Hprt1, and Gapdh levels determined by qPCR.

Expected upcoming milestones

Therapeutic Area / Target



Milestone

NEUROLOGY

Huntington's disease mHTT SNP2		End of 1Q 2021: PRECISION-HD2 data, including complete 32 milligram cohort, and initial data from OLE trial
Huntington's disease mHTT SNP1		End of 1Q 2021: PRECISION-HD1 data, including complete 16 milligram cohort, and initial data from OLE trial
Huntington's disease mHTT SNP3		2021: Dosing of first patient in clinical trial of WVE-003
ALS and FTD C9orf72		2021: Dosing of first patient in clinical trial of WVE-004
Duchenne muscular dystrophy Exon 53		End of 1Q 2021: CTA submission
ADAR editing Multiple		1H 2021: Humanized mouse model validation

First clinical compounds with PN chemistry to begin dosing in 2021

HEPATIC

AATD (ADAR editing) SERPINA1		1H 2021: <i>in vivo</i> AATD data
---------------------------------	--	--

Stereopure PN chemistry

WAVE™
LIFE SCIENCES

ALS: Amyotrophic lateral sclerosis; FTD: Frontotemporal dementia; AATD: Alpha-1 antitrypsin deficiency

WAVE™
LIFE SCIENCES

Realizing a
brighter future
for people
affected by
genetic diseases

For more information:

Kate Rausch, Investor Relations
krausch@wavelifesci.com
617.949.4827

